

DFON graphical displays are used as separate units, but also used in complete instruments, e.g. CombiPress™, CombiTemp™ and CombiLyz™

### Safety instructions

This instrument is built and tested according to the current EU-directives and packed in a technically safe condition. In order to maintain this condition and to ensure safe operation, the user must follow the hints and warnings given in this instruction.

During the installation the valid national rules have to be observed. Ignoring the warnings may lead to severe personal injury or substantial damage to property.

The product must be operated by trained staff. Correct and safe operation of this equipment is dependent on proper transport, storage, installation and operation.

All electrical wiring must conform to local standards. In order to prevent stray electrical radiation, we recommend twisted and shielded input cables, as also to keep power supply cables separated from the input cables. The connection must be made according to the connection diagrams.

Before switching on or off the power supply take care that other equipment is not effected. Ensure that the supply voltage and the conditions in the environment comply with the specification of the device.



### Description

The DFON is powered by the 4...20 mA loop and need no additional power supply. When mounted on new instrument series like the CombiPress™ PFMx it is via the internal UnitCom ribbon cable supplied with power and a digital signal, instead of integrated in the 4...20 mA loop. In instruments with UnitCom both the transmitter and display can be programmed at the same time alternatively separate programming of each device can be selected.

The DFON has an unique background colour setting. Three colours are available – White / Red / Green and further the red and green colour can be set as flashing in warning mode.

The DFON has two integrated galvanic separated relays. The instrument can be delivered with or without activated relays. If supplied without activated relays, those can be activated by purchasing a license code from Baumer. By entering the code to the instrument via the FlexProgrammer the relays are enabled.

The DFON can be programmed by the touch screen on the display or by the FlexProgrammer 9701 Baumer programming unit with the Baumer FlexProgram installed on a PC. (Free download from [www.baumer.com](http://www.baumer.com))

The DFON can be delivered as a stand-alone display or as an integrated part of an instrument e.g. PFMx, TFRx and AFix.

Alternatively it can be delivered as a loop-powered local display for any instrument in a SS case for wall mounting, panel mounting or tube mounting.

### Display mode

There are 10 different display modes available



**Digital**  
small  
large



**Analogue**  
analogue  
same w. bar graph  
same w. value



**Bar graph**  
horizontal  
vertical



**Tank**  
tank illustration  
bottle illustration

## Dimensions for mounting of stand-alone

Wall mounting

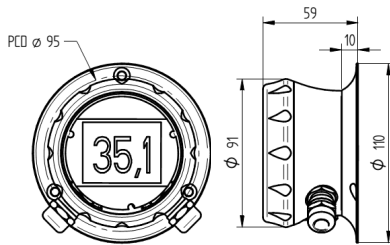

PCD for holes:  $\varnothing 95$  mm

Panel mounting

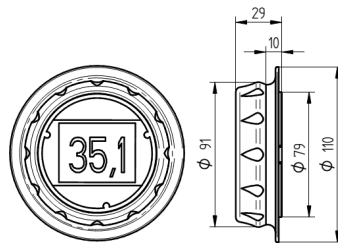

Panel cut out: 80 mm

PCD for holes: 82 mm

Tube mounting

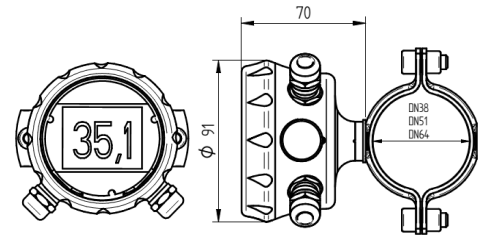

Tube diameter:  $\varnothing 38$  mm

$\varnothing 51$  mm

$\varnothing 64$  mm

## Electrical connection

Pin 1 + 4...20 mA  
Pin 2 - 4...20 mA

Pin 3 Relay 21  
Pin 4 Relay 22

Pin 5 Relay 11  
Pin 6 Relay 12

Com 1 FlexProgrammer ① red  
Com 2 FlexProgrammer ② black

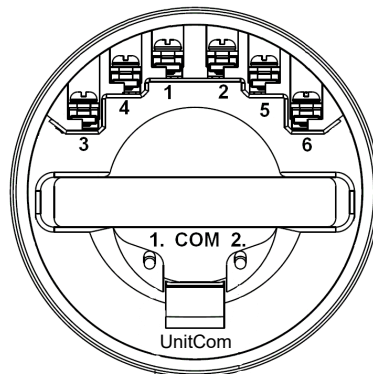

### Cable gland

Cable diameter	M16 plastic	5 ... 10 mm
	M16 stainless steel	5 ... 9 -
	M20 plastic	8 ... 13 -
	M20 stainless steel	11 ... 13 -

- ⚠ Check the maximum temperature for the cable used.
- Be sure to fixate the instrument before tightening the cable gland.
- When using M16 stainless steel and M20 stainless steel the maximum tightening torque is 4 Nm.

Pin 3 and 5 can be jumpered together if common supply is used for the two relays, e.g. via a M12 5-pin connector.

When instruments like PFMx are delivered with DFON display terminal 1 and 2 are not connected. In this case the DFON is powered and will have data through a special ribbon cable (UnitCom). When connected via UnitCom the DFON and transmitter can be programmed together.

- ⚠ When upgrading a product from the CombiSeries without display with a DFON touch screen, remember to remove the O-ring from the sealing. Otherwise the sealing won't be tight.

## Special connection types

For connection 'type B' all the necessary wiring is done inside the DFON housing. It is a "Plug-and-play" solution. Connect:

**PF20x (3-wire)** DFON  
M12 male, 4-pin ↔ M12 female, 4-pin

For connection 'type C' all the necessary wiring is done inside the DFON housing. It is a "Plug-and-play" solution. Connect:

**4...20 mA transmitter (2-wire)** DFON  
M12 male, 4-pin ↔ M12 female, 4-pin

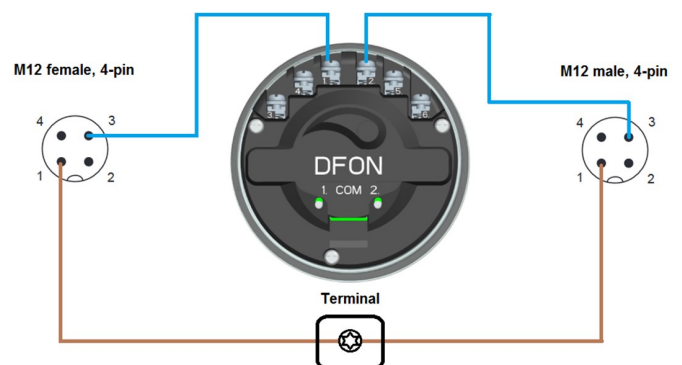
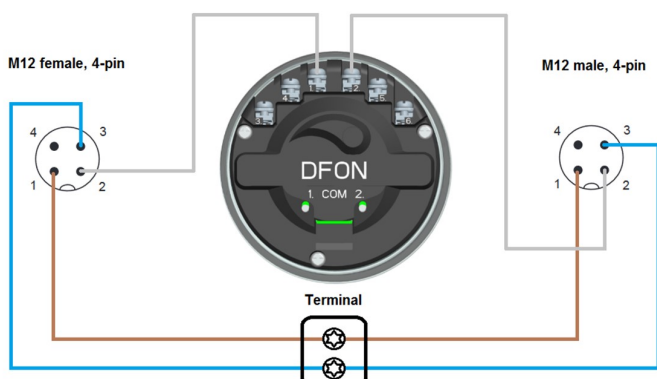

### Electrical connection

For connection 'type D' the following connection diagram has to be followed:

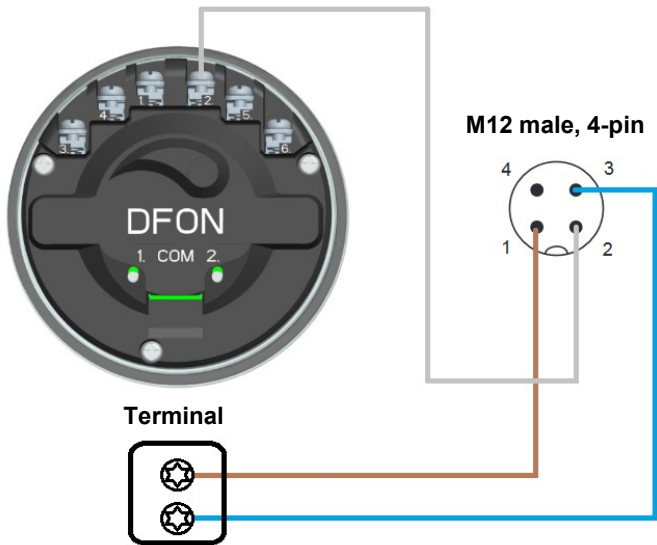
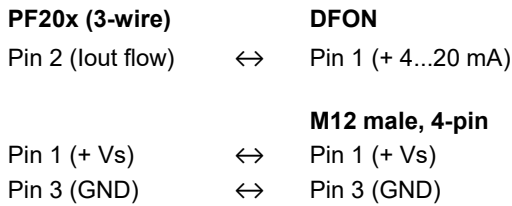

For connection 'type E' the following connection diagram has to be followed:

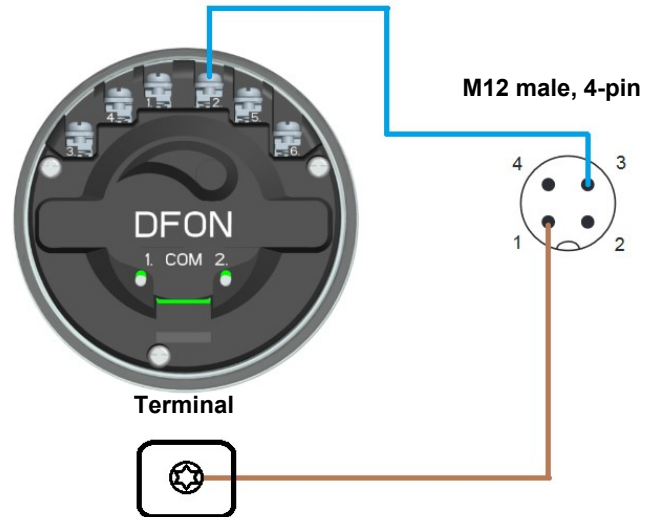
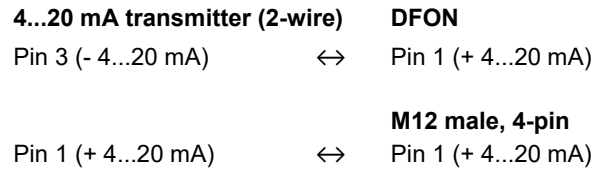

### Touch screen programming the CombiView™, type DFON

Tap on the display screen and the **MENU** button will appear in the bottom. Press **MENU** and the display may start with one out of two possible selections.

With traditional 4...20 mA loop configuration (connected to pin 1 and 2 on the display)

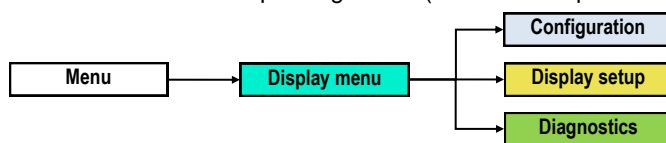

With a transmitter communicating with the DFON via UnitCom ribbon cable

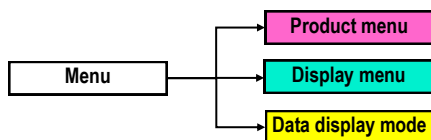

#### Product menu

Enabling the user to set up the connected transmitter

#### Display menu

Enabling the user to program the DFON display

#### Data display mode

Enabling the user to program the connected transmitter. The programmed values will also be valid for the DFON display (Ignoring whatever setup already set on the display).

Only programming of background colours and relays must be done under "Display menu" → "Configuration"

Data display mode will communicate with the transmitter digitally, which is more accurate than using the 4...20 mA communication.





## CombiView™, type DFON - ATEX specifications and instruction

**Zone 0/1 Gas:**      ⚠ II 1 G, Ex ia IIC T5 Gas

**Zone 20/21 Dust:** ⚠ II 1 D, Ex ia IIIC T100°C Da

**Zone 2 Gas:**      ⚠ II 3 G, Ex nA II T5



Please ensure the special requirements for installation in the specific environment is followed, as described below.  
ATEX approval requires the CombiView™, type DFON to be installed in IP67 certified housing.

## Safety instructions

This instrument is constructed and tested according to the current EU directives and packed in a technically safe condition. In order to ensure safe conditions and operation, the user must follow the instructions and warnings given in this instruction and the standard operation instruction.

During the installation the valid national rules have to be observed. Ignoring the instructions may lead to severe personal injury or substantial damage to property.

The product must be installed and operated by trained staff. Correct and safe operation of this equipment is dependent on proper installation and operation.

All electrical wiring must conform to local standards and the connection must be made according to the connection diagrams on the following pages.

Before switching on the power supply take care that other equipment is not affected. Ensure that the supply voltage and conditions in the environment comply with the specification of the device.

Before switching off the supply voltage check the possible effects on other equipment and processing system.

To obtain the specified ingress protection degree, the CombiView™, type DFON must be mounted with a compliant cable.

## Warning

This product is allowed to be operated in an explosion hazardous atmosphere of zone 0 only if atmospheric conditions exists (temperature  $-20^{\circ}\text{C} \dots +60^{\circ}\text{C}$  and pressure from 0.8 ... 1.1 bar). Under other atmospheric conditions the certificate may be used as a guide.

Use of FlexProgrammer 9701 is only allowed in the safe area, not in the hazardous area.

Impact test of the display cover is performed according to EN 60079-0, with low impact energy of 2J and does not create a crack or other intrusion into the housing. However the display, which is mounted close to the front cover may be damaged, but this will not create any external sparking. The housing is impact tested also according to EN 60079-0, with low impact energy of 4J on housing, connectors and cable gland.

This product contains no replaceable parts. In case of malfunction the products must be shipped to Baumer for repair.



### ATEX Gas ia and for ATEX Dust ia

For ATEX ia Gas zone 0/1/2 and ATEX ia Dust zone 20/21/22 a zener barrier must separate the hazardous and safe area, and must be installed in accordance with prevailing guidelines for the zone.

#### ATEX ia Gas / Dust data:

Approval:	ATEX II 1G Ex ia IIC T5 Ga		
	ATEX II 1D Ex ia IIIC T100°C Da		
Voltage drop	$U_{Disp}$	4.5 or 6.5 VDC	
Temperature class	T1...T5	Zone 0 and 20	-20°C...60°C
		Zone 1/2 and 21/22	-40°C...65°C
Internal inductivity	$L_i$	<10 µH	
Internal capacity	$C_i$	<15 nF	
Barrier data	$U_i$	<30 VDC	
	$I_i$	<0.1 A	
	$P_i$	<0.75 W	
Suitable barrier	ZEX-ALL.B28RD100		

The display is supplied by the 4...20 mA loop from the transmitter and can thus be placed near the transmitter or near the power supply, as preferred. However to make the display intrinsic safe a zener barrier must be inserted before the DFON. The transmitter may be placed inside or outside the hazardous area.

If the CombiView™, type DFON is attached to a Baumer transmitter using the UnitCom ribbon cable, it is considered to be an integrated part of the instrument. Please see the ATEX instruction for the relevant instrument.

If the relays are enabled, each relay must be protected by a zener barrier. Use a barrier for each relay or a barrier with multiple channels. However the two relays must have each a barrier.

Barrier data	U	<30 VDC
	I	<75 mA
	P	<0.75 W
Suitable barrier	ZEX-ALL.B30RS075	

Display in the zone, transmitter outside the zone

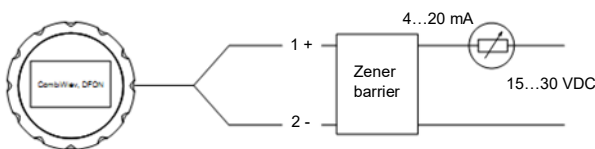

Display and transmitter in the zone

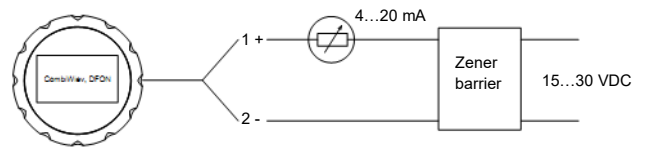

With relay output

Display in the zone/transmitter outside the zone

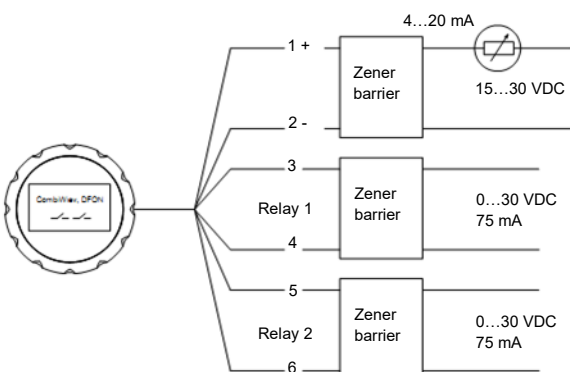

With relay output

Display and transmitter in the zone

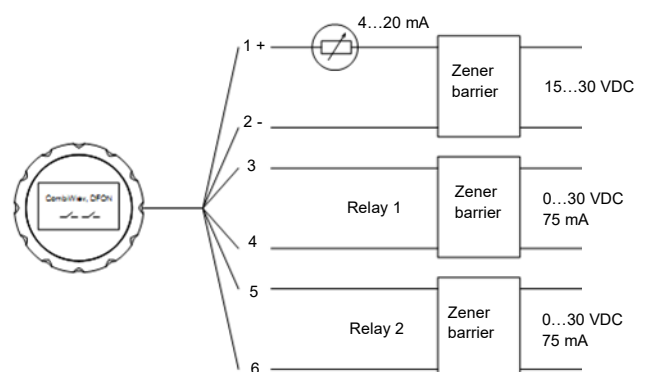



## ATEX Gas nA

For ATEX nA zone 2 is approved without using zener barrier and must be installed in accordance with prevailing guidelines for zone 2.

### ATEX data:

Approval: Gas Zone 2		II 3 G, Ex nA II T5
Voltage drop	$U_{Disp}$	4.5 or 6.5 VDC
Temperature class	T1...T5	$-30 < T_{amb} < 65^{\circ}C$
Internal inductivity	$L_i$	$< 10 \mu H$
Internal capacity	$C_i$	$< 15 nF$
Maximum voltage	$U_{max}$	$< 35 VDC$
Maximum current	$I_{max}$	$< 0.1 A$

Display without relay output

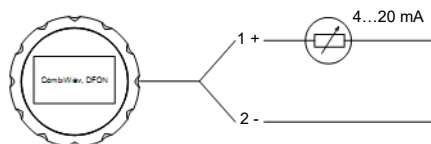

Display with relay output

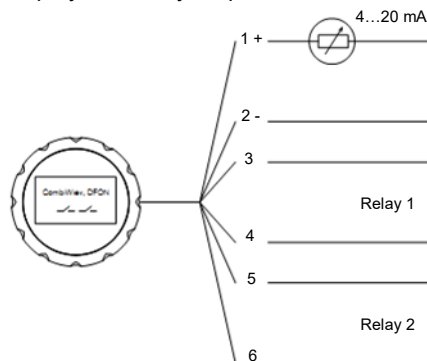

## Programming the CombiView™, type DFON in ATEX area

Programming the CombiView™, type DFON in hazardous area with the FlexProgrammer is not allowed, as the FlexProgrammer (and/or the PC) is not ATEX approved.

Follow below procedure to programme the instrument:

- Disconnect mains from the 4...20 mA loop circuit
- Disconnect the instrument from the circuit within the hazardous area
- Uninstall the instrument and bring it to safe area
- Connect the FlexProgrammer and perform the configuration session.  
(Please see: [www.baumer.com/downloads/product\\_documents/manuals](http://www.baumer.com/downloads/product_documents/manuals) - **DFON - Programming**)
- Reinstall the instrument in the hazardous area
- Connect the instrument to the circuit
- Connect mains from the 4...20 mA loop circuit

### Touch screen programming the CombiView™, type DFON

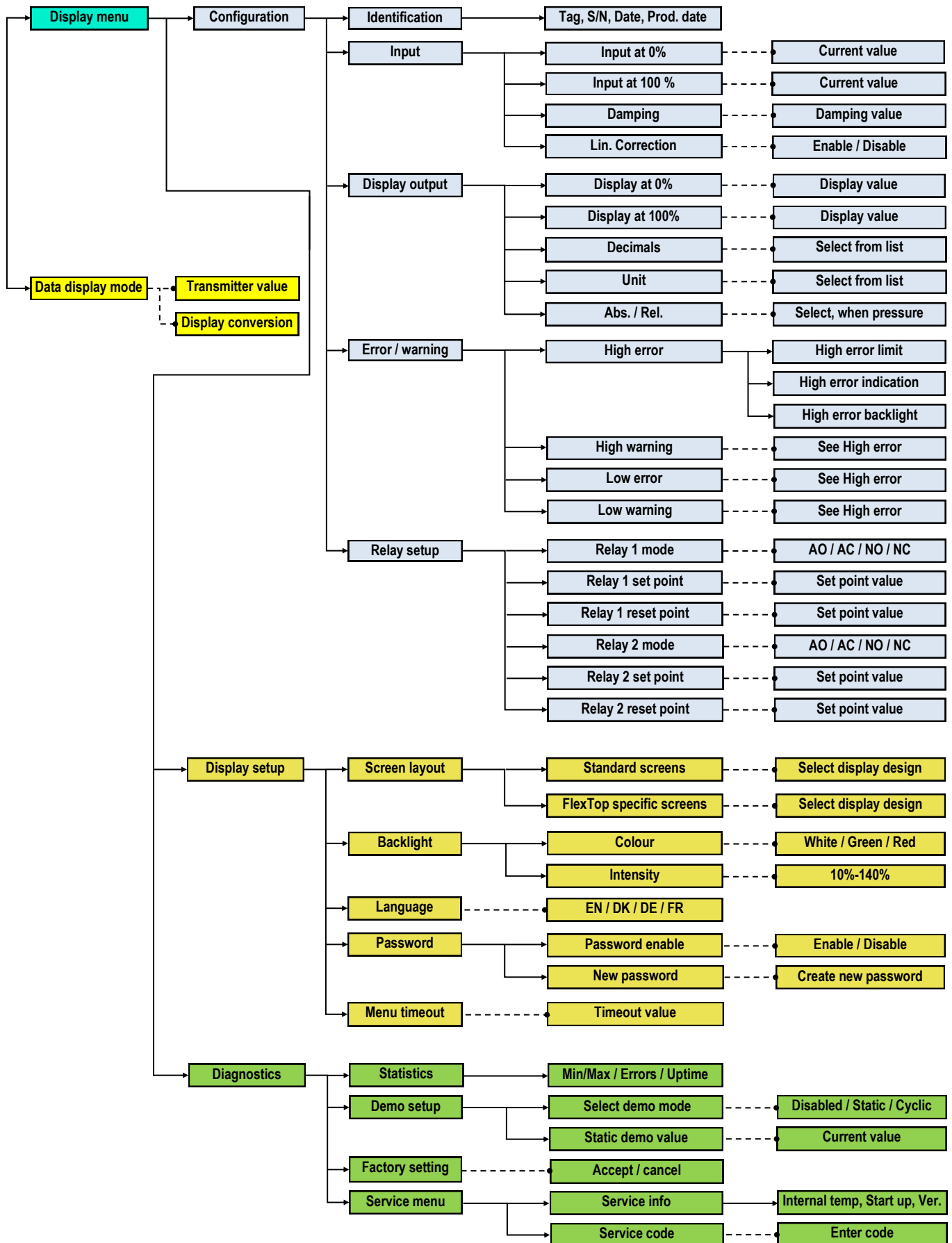

# EU-Konformitätserklärung

## EU Declaration of Conformity

### Déclaration UE de Conformité

Wir erklären in alleiniger Verantwortung, dass die Produkte, auf die sich diese Erklärung bezieht, die grundlegenden Anforderungen der angegebenen Richtlinie(n) erfüllen und basierend auf den aufgeführten Norm(en) bewertet wurden.

We declare under our sole responsibility that the products to which the present declaration relates comply with the essential requirements of the given directive(s) and have been evaluated on the basis of the listed standard(s).

Nous déclarons sous notre seule responsabilité que les produits auxquels se réfère la présente déclaration sont conformes aux exigences essentielles de la directive/ des directives mentionnée(s) et ont été évalués sur la base de la norme/ des normes listée(s).

**Hersteller**

Manufacturer  
Fabricant Baumer A/S

**Bezeichnung**

Description  
Description Prozessanzeigen  
Afficheur de process

**Typ(en) / Type(s) / Type(s)**

DFON-3xxx.xx  
DFON-5xxx.xx

x = beliebige Zahl oder Buchstabe / any figure or letter / n'importe quel nombre ou lettre

**Richtlinie(n)**

Directive(s)  
Directive(s) 2014/30/EU, 2014/34/EU, 2011/65/EU

**Norm(en)**

Standard(s)  
Norme(s) EN 61326-1:2013, EN 60079-0:2012+A11:2013, EN 60079-11:2012, EN 60079-15:2010  
EN 60079-26:2015

**Konformitätsbewertungsstelle:**

Conformity assessment center  
Centre d'évaluation et de mise en conformité TÜV Nord 0044  
Am TÜV 1  
30519 Hannover

**EU- Baumusterprüfbescheinigung:**

EU type examination certificate  
Attestation d'examen UE de type TÜV 13 ATEX 113124 X  
TÜV 13 ATEX 114029 X

**Ort und Datum**

Place and date  
Lieu et date Aarhus, 27.09.2019

**Unterschrift/Name/Funktion**

Signature/name/function  
Signature/nom/fonction



Ib V. Pedersen  
Managing Director

Baumer\_CombiView DFON\_DE-EN-FR\_CoC\_81081694 06.docx

1/1

Baumer A/S  
Runetoften 19  
DK-8210 Aarhus V  
CVR: DK25275071  
VAT. No.: DK11841813

DK Phone +45 8931 7611  
SE Phone +46 (0) 36 13 9430  
sales.dk@baumer.com  
sales.se@baumer.com  
www.baumer.com

Danske Bank: SWIFT: DABADKKK  
(DKK) Konto: 4387-3627293852  
(EUR) IBAN: DK0230003617021021  
(SEK) Bankgiro: 5220-9632

For further information please refer to [www.baumer.com](http://www.baumer.com)