



# Blancett<sup>®</sup> Turbine flow meters

Rugged, accurate and reliable.



Every drop counts.



# Contents

<b>Blancett® turbine meters</b>	<b>2</b>	<b>Blancett® model 1750 – Positive displacement gear flow meters</b>	<b>36</b>
Blancett® turbine meters overview	3	Model 1750 - Positive displacement gear flow meters – Aluminum housing, 85 °C (185 °F) maximum fluid temperature	37
Blancett® flow monitors overview	5	Model 1750 - Positive displacement gear flow meters – 303 stainless steel housing, 205 °C (400 °F) maximum fluid temperature	37
Blancett® accessories overview	6	<b>Flow monitors</b>	<b>39</b>
<b>Blancett® model 1100</b>	<b>7</b>	B2800 / B2900 / B3000 / E110 flow monitors for the Blancett® series	39
Blancett® 1100 standard flow meters with B111109 magnetic pickup	8	<b>Blancett® flow monitor B2800</b>	<b>40</b>
Blancett® 1100 standard flow meters without magnetic pickup	10	B2800 flow monitors, simplified – battery powered	41
Blancett® 1100 standard flow meters – BSPP end connections with B111109 magnetic pickup	12	B2800 flow monitor, explosion proof, simplified – battery powered	42
Blancett® 1100 explosion proof flow meters – for hazardous locations without magnetic pickup	12	B2800 flow monitor, simplified – battery powered (vented)	42
Blancett® 1100 standard flow meters – 304 SS flange connections with B111109 magnetic pickup	14	B2800 flow monitor, simplified – loop powered/4-20 mA (vented)	42
Blancett® 1100 explosion proof flow meters – 304 SS flange connections without magnetic pickup	16	B2800 flow monitor, explosion proof, simplified – loop powered/4-20mA	43
Blancett® 1100 nickel bindery flow meters – for aggressive applications with B111109 magnetic pickup	18	B2800 flow monitor, simplified – loop powered/4-20 mA	43
Blancett® CS-1100 flow meters – for cement slurries with B111109 magnetic pickup	19	B2800 flow monitor, advanced – battery powered	43
<b>Blancett® model 1200</b>	<b>20</b>	B2800 flow monitor, explosion proof, advanced – battery powered	43
Blancett® 1200 turbine flow meters for highly corrosive environments – with B111117 RF pickup and preamplifier	21	B2800 flow monitor, advanced – battery powered (vented)	44
Blancett® 1200 turbine flow meters – without magnetic pickup	22	B2800 flow monitor, advanced – loop powered/4-20 mA	44
<b>Blancett® model 1500</b>	<b>23</b>	B2800 flow monitor explosion proof, advanced – loop powered/4-20 mA	44
Blancett® 1500 turbine flow meters – with B111113 magnetic pickup	24	B2800 flow monitor, advanced – loop powered/4-20 mA (vented)	44
<b>Blancett® QuikSert® turbine flow meters – Liquids</b>	<b>25</b>	<b>Blancett® flow monitor B2900</b>	<b>45</b>
Blancett® QuikSert® turbine flow meter – with B111109 magnetic pickup	26	B2900 flow monitor, loop powered/4-20 mA and battery powered	46
Blancett® QuikSert® explosion proof flow meter for hazardous locations – without magnetic pickup	27	<b>Blancett® flow monitor B3000</b>	<b>47</b>
Blancett® QuikSert® turbine flow meter for cement slurries – with B111109 magnetic pickup	29	B3000 flow monitor, loop powered/4-20 mA and battery powered	49
<b>Blancett® QuikSert® turbine flow meters – Gas</b>	<b>30</b>	<b>Accessories</b>	<b>51</b>
Blancett® QuikSert® Gas – without pickup	31	K-factor scalars	51
<b>FloClean 3-A sanitary turbine meters</b>	<b>32</b>	Frequency converter	53
FloClean B16D 3-A sanitary turbine flow meters (no hub)	33	Intelligent frequency converter (analog)	54
FloClean B16D 3-A sanitary turbine flow meters (with hub)	34	Preamplifier (digital)	54
		Magnetic pickups	54
		Cable and connector options	55
		Bushing reducer	56
		Explosion proof kit (hazardous location)	56
		<b>Appendix</b>	<b>57</b>
		Example 5 point calibration protocol for liquid flow meters	57
		Example 5 point calibration protocol for gas flow meters	58

# Turbine meters

Turbine meters are best suited for low viscosity fluids and also gases.

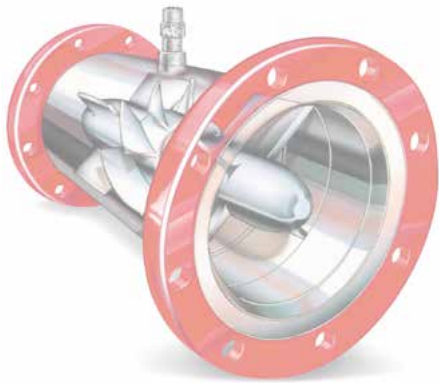

## Measuring principle

Turbine meters are indirect volumetric meters. When the fluid passes through, a rotor is activated and the movement is then either electronically or mechanically transmitted.

## Blancett® turbine meters



- Petrochemical
- Oil and Gas
- Food and Beverage
- Semiconductor
- Irrigation
- Chemical
- Industrial
- Refining

### Rugged meters for harsh environments, high corrosive media or for food and pharmaceutical industry - accurate and reliable

Badger Meter offers the Blancett® family of turbine flow meters to measure everything from water in hydraulic fracturing and mining operations, to gases and liquids from wellheads to sanitary environments. Our turbine meters deliver accurate and reliable flow measurements for both liquid and gas applications. Blancett® turbine meters are also cost-effective and easy to repair. Both complete meters and repair kits receive a five-point NIST traceable calibration at the factory. Additional calibrations are available to achieve a higher accuracy rating or

to custom-calibrated for a specific viscosity. The B1500 meters receive a 10-point NIST traceable calibration. To satisfy your flow metering needs, Badger Meter provides a full line of cost effective flow monitors to fit a variety of application demands including hazardous area locations, pulse and network communications and a variety of mounting options. The flow monitors are designed to be used with Blancett® flow meters, but can also be used with almost any flow meter producing a low amplitude AC output. The Blancett® family is offered with an assortment

of accessories that deliver output signals to suit the inputs required by data acquisition or control systems. Available accessories include turbine meter pickups, K-factor scaler, frequency-to-analog transmitters, frequency-to-square wave transmitters and displays.

## Blancett® turbine meters overview



Type	1100	1200	1500
Medium	for fluids	for fluids	for fluids
Material	Housing: 316 stainless steel Rotor: CD4MCU stainless steel Bearings: 316 stainless steel Rotor shaft: Tungsten carbide	Housing: 303 stainless steel Rotor: CD4MCU stainless steel Bearings: 440 stainless steel Rotor support & shaft: 303 stainless steel	Housing: 316 stainless steel Rotor: 17-4 stainless steel Bearings: Ceramic Rotor shaft: 316 stainless steel
Measuring range	2,3 – 19.000 l/min	0,95 – 95 l/min	0,95 - 947 l/min
Size	½" up to 10"	¼", ½", ¾"	¼" up to 2"
Flow accuracy	± 1 % of reading for 7/8" and larger meters ± 1 % of reading over the upper 70 % of the measuring range for ¾", ½" and ¼" meters	± 0,5 % of reading	± 0,5 % of reading ± 0,25 % of reading monitor and linearization
Repeatability	± 0,1 %	± 0,1 %	± 0,02 %
Calibration	Water (NIST traceable calibration); other media upon request	Water (NIST traceable calibration); other media upon request	Solvent (NIST traceable calibration) 10-point calibration
Pressure ratings*	345 bar max.	276 bar max.	408 bar max.
Operating temperature	Up to 177 °C (standard) Up to 232 °C (with high temperature pickup B220111)	Up to 162 °C	-65 °C up to +148 °C
End connections	NPT, BSP, Victaulic®, Flange, Hose Barbed or Grayloc®	NPT	NPT Flange
Approvals	CSA Class I Div 1, Groups C & D; Class II Div 1, Groups E, F & G: intrinsically safe CSA Class I Div 1 Groups C, D; complies to UL 1203 and CSA 22.2 N° 30 Met Labs File No. E112860 (for explosion proof models only)	-	-

\* End connection dependent

## Blancett® turbine meters overview



Type	FloClean	QuikSert®	
<b>Medium</b>	for fluids	for fluids	for gases
<b>Material</b>	Housing: 316 L stainless steel Bearings: CD4MCU stainless steel, nickel plated Standard bearings: Nickel bindery, tungsten carbide Bearing shaft: Nickel bindery, tungsten carbide	Housing: 316 L stainless steel Rotor: CD4MCU stainless steel Bearings: Tungsten carbide Rotor shaft: Tungsten carbide	Housing: 316 L stainless steel Rotor: 410/304 stainless steel Bearings: Tungsten carbide
<b>Measuring range</b>	2,5 – 1.500 l/min	2,3 – 19.000 l/min	7 – 350 ACFM / 12 - 583 m³/h
<b>Size</b>	¾" up to 2 ½"	¾" up to 10"	2"
<b>Flow accuracy</b>	± 1 % of reading	± 1 % of reading	± 1 % of reading with monitor or flow transmitter
<b>Repeatability</b>	± 0,1 %	± 0,1 %	± 0,5 %
<b>Calibration</b>	Water (NIST traceable calibration);	Water (NIST traceable calibration); other media upon request	Air (NIST traceable calibration)
<b>Operating pressure</b>	69 bar	Depending of the chosen flange connections up to 255 bar	Vacuum 15.3 mPa max.
<b>Operating temperature</b>	Up to 149 °C	Up to 177 °C	-40 °C up to +165 °C
<b>End connections</b>	Sanitary Tri-Clamp®	Wafer-style ASME/ANSI B16.5 – 1996	Wafer-style ASME/ANSI B16.5 – 1996
<b>Approvals</b>	3-A sanitary standard	For explosion proof models only: Class I Div 1 Groups C, D; Complies to UL 1203 and CSA 22.2 N°. 30; Met Labs File N° E112860	Class I Div 1, Groups C, D; Complies to UL 913 and CSA 22.2 N° 157-92

## Blancett® flow monitors overview



Type	B2800	B2900	B3000	E110
<b>Power supply</b>	1.5 VDC alkaline battery or 4 – 20 mA / 30 VDC loop-powered	3.6 V lithium battery or 4 - 20 mA loop-powered	3.6 V lithium battery 4 – 20 mA loop-powered Solar-powered	9 – 27V DC + sensor supply 3.6 V lithium battery
<b>Mounting possibilities</b>	Meter mounted <sup>1</sup> Remote mount Swivel mount Panel mount Explosion proof, remote mount <sup>2</sup>	Meter mounted <sup>1</sup> Remote mount Swivel mount	Meter mounted <sup>1</sup> Remote mount Swivel mount Explosion proof, remote mount <sup>2</sup>	Meter mounted
<b>Outputs</b>	4 – 20 mA Pulse output	4 – 20 mA Pulse output ModBus® RTU Open collector	4 – 20 mA Pulse output ModBus® RTU over RS 485 (B30 Advanced)	4 – 20 mA (NPN) Passive transistor output
<b>Approvals</b>	CSA intrinsically safe (for meter mounted, remote and swivel mounted): Class I, Division 1, Groups C & D Class II, Division 1, Groups E, F, G  CE (for meter mounted, remote and swivel mounted): IEC 61326-1  CSA hazardous locations (explosion proof): Class I, Division 1, Groups B, C & D Class II, Groups E, F & G / Class III, Type 4, T6@70 C	Class I, Division 1, Groups C, D Class II, Division 1, Groups E, F, G Class III for USA and Canada. Corresponds to UL 913 and CSA C22.2 n° 153 EMC: IEC 61326-1; 2004/108/EC	B30 Advanced/Base/Solar: Class I, Division 1, Groups C, D Class II, Division 1, Groups E, F, G Class III for USA and Canada Corresponds to UL 913 and CSA C22.2 n° 157-92.  B30 explosion proof Advanced/Base: Class I, Division 1, Groups B, C, D Class II, Division 1, Groups E, F, G Class III for USA and Canada complies with UL 1203 and CSA C22.2 n° 30-M1986.  B30 explosion proof Advanced/Base: ATEX II 2 G Ex d IIC T4 Gb and ATEX II D Ex tb IIC T125 °C Db	ATEX Gas: $\text{Ex}$ II 2G Ex d IIC T6 Gb Dust: $\text{Ex}$ II 2D tb IIIC T85 °C Db  IECEx Gas: Ex d IIC T6 Gb Dust: Ex tb IIIC T85°C Db  FM & CSA <sub>C-US</sub> Class I, Div. 1, Groups A, B, C, D. Class II/III, Div. 1, Groups E, F, G Class I, Zone 1, AEx d IIC T6 Gb, Zone 21, AEx tb IIIC T85°C Db.
<b>Enclosure rating</b>	NEMA 4X (IP 66)	NEMA 4X (IP 66)	NEMA 4X (IP 66)	NEMA 4X, NEMA 7, NEMA 9 (IP 66, IP67)

<sup>1</sup> Bushing reducer required for ½" hub turbine meters to mount accessories on meter (see "Table 58" on page 56)

<sup>2</sup> Explosion proof kit for explosion proof system required (see "Table 59" on page 56)



## Blancett® accessories overview



Type	K-factor scaler	Canister style intelligent converter <sup>1</sup>		Conduit elbow style intelligent converter	
<b>Description</b>	The Blancett® K-factor scaler converts the output of a Blancett® turbine flow meter, or other low-level frequency output, into a scaled square wave output signal which then translates into the desired units of measure.	The active sensor is designed for use with turbine meters, the sensor measures and calculates the flow rate to produce an analog current or voltage output representative of the meter's flow rate. <ul style="list-style-type: none"> <li>• Converts turbine pulse output into linearized analog output</li> <li>• Choice of 4 to 20 mA or 0 to 5V DC</li> </ul>			
<b>Power</b>	External power Input voltage: 8.5 - 30V DC Maximum current draw: 18 mA (using internal resistor @ 30V DC input)	<b>F to I / Frequency to current</b> <b>B220-950</b> 10-26V DC	<b>F to V / Frequency to voltage</b> <b>B220-951</b> 10-26V DC	<b>F to I / Frequency to current</b> <b>B220-873</b> 10-30V DC	<b>F to V / Frequency to voltage</b> <b>B220-874</b> 10-26V DC
<b>Inputs (magnetic pickup)</b>	Frequency range: 0-4000 Hz	Frequency: 0-3500 Hz Frequency measurement accuracy: ± 1%		Frequency: 0-3500 Hz Frequency measurement accuracy: ± 1%	
<b>Output</b>	Max. voltage: 30V DC Max. power: 0.25 W	Analog output: 4-20 mA	Analog output: 0-5V DC	Analog output: 4-20 mA	Analog output: 0-5V DC
<b>Environmental</b>	Operating temperature: -30 to +70 °C	Operating temperature: -30 up to +70 °C		Operating temperature: -30 up to +70 °C	
<b>Approvals</b>	<b>Model B220-885:</b> Killark aluminum-capped elbow, Y3 CSA approved Class I, Div 1 & 2, Groups C, D; Class II, Div 1 & 2, Groups E, F, G; and Class III <b>Models B220-880, B220-881, B220-882:</b> Appleton GR conduit outlet box GRL100-A and GRLB100A, CSA approved Class I, Div 1, Groups B, C, D; Class II, Groups E, F, G; and Class III			Killark aluminum-capped elbow, Y3 CSA approved Class I, Div 1 & 2, Groups C, D; Class II, Div 1 & 2, Groups E, F, G; and Class III	
<b>Programming kit</b>	Part number: B220-900 (for use with K-factor scaler B220-885)	B220-953		B220-954	

<sup>1</sup> Includes magnetic pickup.

# Blancett® model 1100



- Broad flow range and mechanical process connections
- Wide variety
- Simple installation

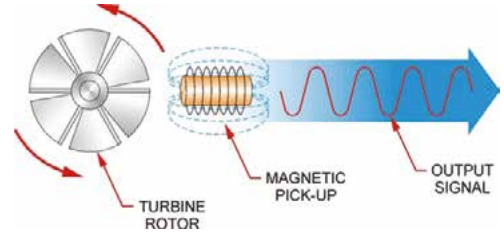

Illustration of electrical signal generated by rotor movement

## Blancett® 1100 standard turbine flow meters

Model 1100 turbine flow meter withstands the demands of the most rigorous flow measurement applications. Designed to maintain accuracy and mechanical integrity, its rugged 316 stainless steel construction ensures a long service life in severe operating environments.

It meets a wide range of measurement requirements and integrates electronically with the Blancett® flow monitors, K-factor scaler or the F to I/F to V intelligent converters. Originally developed for the secondary oil recovery market, the model 1100 is an ideal

meter for nearly all liquid flow measurement on or off the oilfield. All meters will be provided with a 5-point calibration certificate, standard calibrated with water (1.0 S.G.) or optionally with oil (0.876 S.G.)

## Specifications

Materials of construction	Body	316 stainless steel
	Rotor	CD4MCU stainless steel
	Rotor support	316 stainless steel journal bearings
	Rotor shaft	Tungsten carbide
Turndown ratio	10:1	
Flow accuracy	± 1% of reading for 7/8" and larger meters	
	± 1% of reading over the upper 70% of the measuring range for 3/8", 1/2" and 3/4" meter size	
Repeatability	± 0.1%	
Calibration	Water (NIST traceable calibration)*	
Turbine temperature	-101 to +165 °C (-150 to +330 °F) with magnetic pickup (B111109)	
	-101 to +232 °C (-150 to +450 °F) with high temperature pickup (B220111)	
Approvals	CSA Class I Div 1, Groups C & D   Class II Div 1, Groups E, F & G: intrinsically safe	
	CSA Class I Div 1 Groups C,D; complies to UL 1203 and CSA 22.2 No. 30	
	Met Labs File No. E112860 (for explosion proof models only)	

\*Example 5 point calibration protocol for liquid flow meters see appendix on page 57

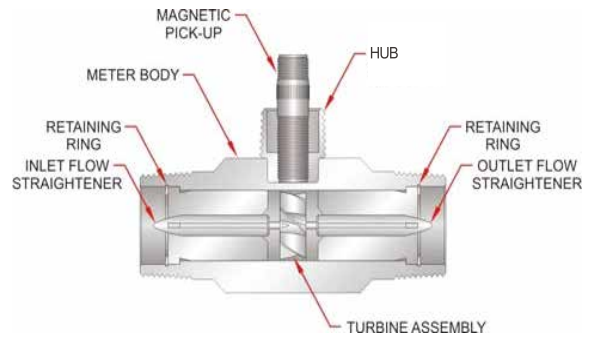
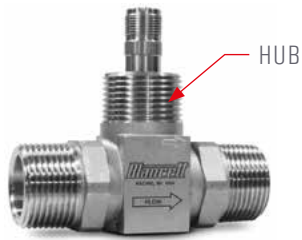

## Blancett® 1100 standard flow meters with B11109 magnetic pickup

Part number <sup>1</sup>	Meter size	Hub size	End connection	Maximum pressure	Flow rate		K-factor <sup>2</sup>		Meter weight (kg)	End-to-end length
					gal/min	l/min	pulses/gal	pulses/liter		
B110-375-½	3/8"	½" NPT	½" × ½" male NPT	345 bar (5000 psi)	0,6 - 3	2,3 - 11,4	18000	4749	0,5	76,2 mm (3")
B110-500-½	½"				0,75 - 7,5	2,8 - 28,4	13000	3430	0,5	76,2 mm (3")
B110-750-½	¾"				2 - 15	7,6 - 56,8	3300	870	0,5	76,2 mm (3")
B110-375	3/8"	1" × 1" male NPT	1" × 1" male NPT		0,6 - 3	2,3 - 11,4	18000	4749	0,9	101,6 mm (4")
B110-500	½"				0,75 - 7,5	2,8 - 28,4	13000	3430	0,9	101,6 mm (4")
B110-750	¾"				2 - 15	7,6 - 56,8	3300	870	0,9	101,6 mm (4")
B110-875	7/8"				3 - 30	11,4 - 113,6	3100	818	0,9	101,6 mm (4")
B111-110	1"				5 - 50	18,9 - 189,2	870	229	0,9	101,6 mm (4")
B111-115	1½"				1½" × 1½" male NPT	15 - 180	56,8 - 681,4	330	87	2,3
B111-121	1½"	2" × 2" male NPT	15 - 180		56,8 - 681,4	330	87	2,7	152,4 mm (6")	
B111-120	2"	2" × 2" female NPT	40 - 400		151,4 - 1514,2	52	13	2,7	245 mm (10")	
B311-066	2"	1" NPT	Grooved end		40 - 400	151,4 - 1514,2	52	13	6,4	317,5 mm (12 ½")
B311-004	3"		3" × 3" male NPT	60 - 600	227,2 - 2271,2	57	15	6,8	304,8 mm (12")	
B111-130	3"		Grooved end	60 - 600	227,2 - 2271,2	57	15	6,8	304,8 mm (12")	
B311-084	4"		4" × 4" male NPT	100 - 1200	378,5 - 4542,5	29	7,6	9,1	304,8 mm (12")	
B111-140	4"		Grooved end	100 - 1200	378 - 4542	29	7,6	9,1	304,8 mm (12")	
B311-085	6"		6" × 6" male NPT	200 - 2500	757 - 9463,5	7	1,8	21	304,8 mm (12")	
B111-160	6"		200 - 2500	757 - 9463,5	7	1,8	21	304,8 mm (12")		
B111-180	8"		Grooved end	250 - 3500	946,4 - 13249	3	0,8	25,4	304,8 mm (12")	
B111-200	10"		500 - 5000	1892,7 - 18927	1,6	0,4	36,3	304,8 mm (12")		

<sup>1</sup> Includes standard magnetic pickup, p/n B111109, -101 to +165 °C (-150 to +330 °F), suitable for all mounting styles

<sup>2</sup> All K-factors are approximate

## Configuration examples

The Blancett® family is offered with an assortment of accessories that deliver output signals to suit the inputs required by data acquisition or control systems. Available accessories include monitors, turbine meter pickups, frequency-to-analog transmitters and frequency-to-square wave transmitters.

### Monitor

Mounting	Hub size	Turbine with magnetic pickup <sup>1</sup>	Bushing reducer	Cable <sup>2</sup>	Monitor <sup>3</sup>
Meter mounted display	½" NPT	B110-375-½	B220056 or B220057	-	B30AM-CS
Meter mounted display	1" NPT	B111-110	not required	-	B30AM-CS
Remote mounted display (with cable)	not required	B111-110	not required	B220-220 or B220-221	B30AR-CS

<sup>1</sup> Turbine with magnetic pickup: see "Table 1" on page 8

<sup>2</sup> Cable: see "Table 52" on page 55

<sup>3</sup> Monitor: see "Table 45" on page 49

### K-factor scaler

Mounting	Hub size	Turbine with magnetic pickup <sup>1</sup>	Bushing reducer	K-factor scaler <sup>2</sup>	Programming software <sup>3</sup>
Meter mounted	½" NPT	B110-375-½	B220056 or B220057	B220-885	B220-900
Meter mounted	1" NPT	B111-110	not required	B220-885	B220-900

<sup>1</sup> Turbine with magnetic pickup: see "Table 1" on page 8

<sup>2</sup> K-factor scaler: see "Table 48" on page 52

<sup>3</sup> Software: see "Table 48" on page 52



### F to I intelligent converter

Mounting	Hub size	Turbine with magnetic pickup <sup>1</sup>	Bushing reducer	F to I intelligent converter <sup>2</sup>	Programming kit <sup>3</sup>
Meter mounted	½" NPT	B110-375-½	B220056 or B220057	B220-873	B220-954
Meter mounted	1" NPT	B111-110	not required	B220-873	B220-954

<sup>1</sup> Turbine with magnetic pickup: see "Table 1" on page 8

<sup>2</sup> F to I converter: see "Table 49" on page 54

<sup>3</sup> Programming kit: see "Table 49" on page 54

### F to V intelligent converter

Mounting	Hub size	Turbine with magnetic pickup <sup>1</sup>	Bushing reducer	F to V intelligent converter <sup>2</sup>	Programming kit <sup>3</sup>
Meter mounted	½" NPT	B110-375-½	B220056 or B220057	B220-874	B220-954
Meter mounted	1" NPT	B111-110	not required	B220-874	B220-954

<sup>1</sup> Turbine with magnetic pickup: see "Table 1" on page 8

<sup>2</sup> F to V converter: see "Table 49" on page 54

<sup>3</sup> Programming kit: see "Table 49" on page 54

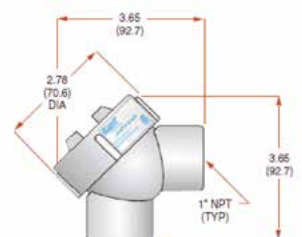

**Conduit elbow style**  
Model B220-873 & B220-874

## Blancett® 1100 standard flow meters without magnetic pickup

Part number <sup>1</sup>	Meter size	Hub size	End connection	Maximum pressure	Flow rate		K-factor <sup>2</sup>	
					gal/min	l/min	pulses/gal	pulses/liter
B112-375-½	3/8"	½" NPT	½" × ½" male NPT	345 bar (5000 psi)	0,6 - 3	2,3 - 11,4	18000	4749
B112-500-½	½"				0,75 - 7,5	2,8 - 28,4	13000	3430
B112-750-½	¾"				2 - 15	7,6 - 56,8	3300	870
B112-375	3/8"	1" × 1" male NPT	1" × 1" male NPT		0,6 - 3	2,3 - 11,4	18000	4749
B112-500	½"				0,75 - 7,5	2,8 - 28,4	13000	3430
B112-750	¾"				2 - 15	7,6 - 56,8	3300	870
B112-875	7/8"				3 - 30	11,4 - 113,6	3100	818
B112-110	1"				5 - 50	18,9 - 189,2	870	229
B112-115	1½"				15 - 180	56,8 - 681,4	330	87
B112-121	1½"	1" NPT	2" × 2" male NPT		15 - 180	56,8 - 681,4	330	87
B112-120	2"		2" × 2" female NPT		40 - 400	151,4 - 1514,2	52	13
B112-130	3"		Grooved end		Grooved end	60 - 600	227,2 - 2271,2	57
B112-140	4"	100 - 1200		378,5 - 4542,5		29	7,6	
B112-160	6"	200 - 2500		757 - 9463,5		7	1,8	
B112-180	8"	250 - 3500		946,4 - 13249		3	0,8	
B112-200	10"	55 bar (800 psi)		500 - 5000		1892,7 - 18927	1,6	0,4

<sup>1</sup> Requires purchase of separate pickup, see "Table 3" on page 10 for available options.

<sup>2</sup> All K-factors are approximate.

Table 2

## Model 1100 pickup options

Part number	Magnetic pickup	Temperature range
B111109	Standard	-101 °C to +165 °C (-150 °F to 330 °F)
B111126	ATEX  II 1G; EEx ia IIC T5	-50 °C to +120 °C (-58 °F to 248 °F)
B220111	High temperature	-101 °C to +232 °C (-150 °F to 450 °F)
B220210	With preamplifier	-29 °C to +71 °C (-20 °F to 160 °F)
B220243	Intrinsically safe, FM rated	-101 °C to +165 °C (-150 °F to 330 °F)

Table 3

## Configuration examples

Monitor						
Mounting	Hub size	Turbine without pickup <sup>1</sup>	Magnetic pickup <sup>2</sup>	Bushing reducer	Cable <sup>3</sup>	Monitor <sup>4</sup>
Meter mounted display	½" NPT	B112-375-½	B111109	B220056 or B220057	-	B30AM-CS
Meter mounted display	1" NPT	B112-375	B111109	-	-	B30AM-CS
Remote mounted display (with cable)	not required	B112-375-½	B111109	-	B220-220 or B220-221	B30AR-CS

<sup>1</sup> Turbine example: see "Table 2" on page 10

<sup>2</sup> Pickup: see "Table 3" on page 10

<sup>3</sup> Cables: see "Table 52" on page 55

<sup>4</sup> Monitor: see "Table 45" on page 49

F to I intelligent converter						
Mounting	Hub size	Turbine without pickup <sup>1</sup>	Bushing reducer	F to I intelligent converter <sup>2</sup>	Programming kit <sup>3</sup>	Cable <sup>4</sup>
Meter mounted	½" NPT	B112-375-½	not required	B220-950 (includes magnetic pickup)	B220-953	B220952-6
Meter mounted	1" NPT	B112-110	not required	B220-950 (includes magnetic pickup)	B220-953	B220952-6

<sup>1</sup> Turbine example: see "Table 2" on page 10

<sup>2</sup> F to I converter: see "Table 49" on page 54

<sup>3</sup> Programming kit: see "Table 49" on page 54

<sup>4</sup> Cables: see "Table 55" on page 55

F to V intelligent converter						
Mounting	Hub size	Turbine <sup>1</sup> without pickup	Bushing reducer	F to V intelligent converter <sup>2</sup>	Programming kit <sup>3</sup>	Cable <sup>4</sup>
Meter mounted	½" NPT	B112-375-½	not required	B220-951 (includes magnetic pickup)	B220-953	B220952-6
Meter mounted	1" NPT	B112-110	not required	B220-951 (includes magnetic pickup)	B220-953	B220952-6

<sup>1</sup> Turbine example: see "Table 2" on page 10

<sup>2</sup> F to V converter: see "Table 49" on page 54

<sup>3</sup> Programming kit: see "Table 49" on page 54

<sup>4</sup> Cables: see "Table 55" on page 55



Canister style  
Model B220-950 & B220-951

Pre-amplifier (square wave output)		
Turbine without pickup <sup>1</sup>	Magnetic pickup with pre-amplifier <sup>2</sup>	Cable <sup>3</sup>
B112-375	B220210	B220-219

<sup>1</sup> Turbine example: see "Table 2" on page 10

<sup>2</sup> Pickup: see "Table 3" on page 10

<sup>3</sup> Cables: see "Table 53" on page 55

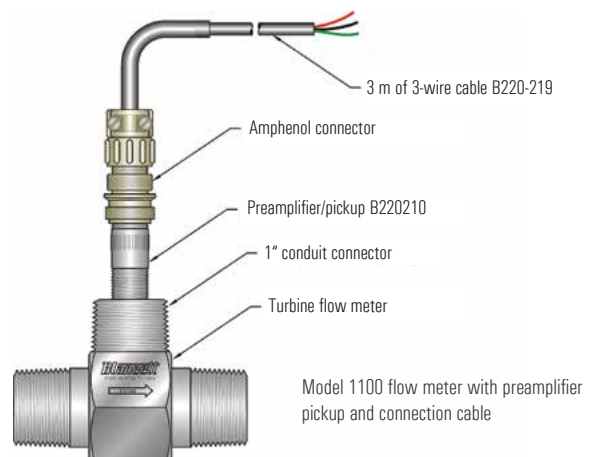

Model 1100 flow meter with pre-amplifier pickup and connection cable

## Blancett® 1100 standard flow meters – BSPP end connections with B11109 magnetic pickup

Part number <sup>1</sup>	Meter size	Hub size	End connection	Maximum pressure	Flow rate		K-factor <sup>2</sup>	
					gal/min	l/min	pulses/gal	pulses/liter
B114-375-½	3/8"	½" NPT	½" × ½" male BSP	345 bar (5000 psi)	0,6 - 3	2,3 - 11,4	18000	4749
B114-500-½	½"				0,75 - 7,5	2,8 - 28,4	13000	3430
B114-750-½	¾"				2 - 15	7,6 - 56,8	3300	870
B114-375	3/8"	1" NPT	1" × 1" male BSP		0,6 - 3	2,3 - 11,4	18000	4749
B114-500	½"				0,75 - 7,5	2,8 - 28,4	13000	3430
B114-750	¾"				2 - 15	7,6 - 56,8	3300	870
B114-875	7/8"				3 - 30	11,4 - 113,6	3100	818
B114-110	1"				5 - 50	18,9 - 189,2	870	229
B114-115	1½"				15 - 180	56,8 - 681,4	330	87

<sup>1</sup> Includes standard magnetic pickup, p/n B111109, -101 to +165 °C (-150 to +330 °F), suitable for all mounting styles.

<sup>2</sup> All K-factors are approximate.

Table 4

## Blancett® 1100 explosion proof flow meters – for hazardous locations without magnetic pickup

Part number <sup>1</sup>	Meter size	Hub size	End connection	Maximum pressure	Flow rate		K-factor <sup>2</sup>		
					gal/min	l/min	pulses/gal	pulses/liter	
B110C-375-½	3/8"	½" NPT	½" × ½" male NPT	345 bar (5000 psi)	0,6 - 3	2,3 - 11,4	18000	4749	
B110C-500-½	½"				0,75 - 7,5	2,8 - 28,4	13000	3430	
B110C-750-½	¾"				2 - 15	7,6 - 56,8	3300	870	
B110C-375	3/8"	1" NPT	1" × 1" male NPT		0,6 - 3	2,3 - 11,4	18000	4749	
B110C-500	½"				0,75 - 7,5	2,8 - 28,4	13000	3430	
B110C-750	¾"				2 - 15	7,6 - 56,8	3300	870	
B110C-875	7/8"				3 - 30	11,4 - 113,6	3100	818	
B111C-110	1"				5 - 50	18,9 - 189,2	870	229	
B111C-115	1½"				15 - 180	56,8 - 681,4	330	87	
B111C-121	1½"	1" NPT	2" × 2" male NPT	15 - 180	56,8 - 681,4	330	87		
B111C-120	2"		2" × 2" female NPT	40 - 400	151,4 - 1514,2	52	13		
B111C-130	3"		Grooved end	55 bar (800 psi)	60 - 600	227,2 - 2271,2	57	15	
B111C-140	4"	100 - 1200			378,5 - 4542,5	29	7,6		
B111C-160	6"	200 - 2500			757 - 9463,5	7	1,8		
B111C-180	8"	250 - 3500			946,4 - 13249	3	0,8		
B111C-200	10"					500 - 5000	1892,7 - 18927	1,6	0,4

**Approvals:** CSA Class I Div 1, Groups C & D; Class II Div 1, Groups E, F & G: intrinsically safe; CSA Class I Div 1 Groups C, D; complies to UL 1203 and CSA 22.2 N° 30; Met Labs File No. E112860

<sup>1</sup> Requires purchase of separate pickup (options can be found in "Table 6" on page 12)

<sup>2</sup> All K-factors are approximate.

Table 5

## Model 1100 explosion proof meters – pickup options

Part number	Magnetic pickup	Temperature range
B111109	Standard	-101 °C to +165 °C (-150 °F to 330 °F)
B111126	ATEX  II 1G; EEx ia IIC T5	-50 °C to +120 °C (-58 °F to 248 °F)
B220243	Intrinsically safe, FM rated	-101 °C to +165 °C (-150 °F to 330 °F)

Table 6

## Configuration examples

For hazardous location – Explosion proof				
Hub size	Turbine (no pickup) <sup>1</sup>	Magnetic pickup <sup>2</sup>	Explosion proof meter mount kit	Explosion proof monitor <sup>3</sup>
½" NPT	B110C-375-½	B111109	B280-742	B30XR-CS
1" NPT	B111C-110	B111109	B280-737	B30XR-CS

<sup>1</sup> Turbine example: see "Table 5" on page 12

<sup>2</sup> Pickup: see "Table 6" on page 12

<sup>3</sup> Monitor: see "Table 45" on page 49; Approvals see page 48

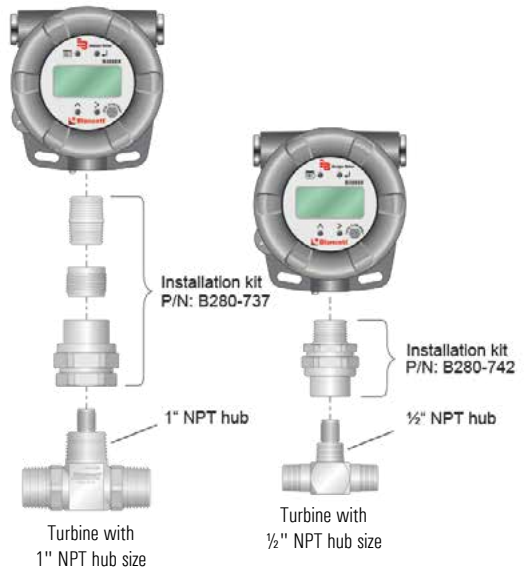

For hazardous location – Intrinsically safe					
Hub size	Turbine without pickup	Magnetic pickup <sup>2</sup>	Cable	In non hazardous location	Explosion proof monitor <sup>3</sup>
½" NPT	B110C-375-½	B111126	B220-220 or B220-221	I.S. barrier and display	B30XR-CS
1" NPT	B111C-110	B111126	B220-220 or B220-221	I.S. barrier and display	B30XR-CS
½" NPT	B110C-375-½	B220243	B220-220 or B220-221	I.S. barrier and display	B30XR-CS
1" NPT	B111C-110	B220243	B220-220 or B220-221	I.S. barrier and display	B30XR-CS

<sup>1</sup> Turbine example: see "Table 5" on page 12

<sup>2</sup> Pickup: see "Table 6" on page 12

<sup>3</sup> Monitor: see "Table 45" on page 49; Approvals see page 48

I.S. barrier not available

## Wiring example for B111126

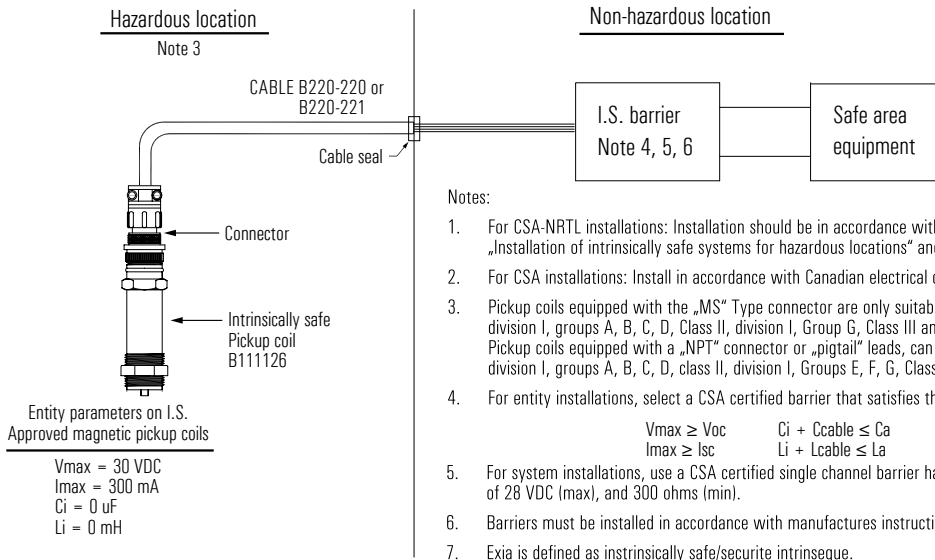

ATEX				
Hub size	Turbine without pickup <sup>1</sup>	Magnetic pickup <sup>2</sup>	Bushing reducer	ATEX monitor <sup>2</sup>
½" NPT	B110C-375-½	B111126	B220056 or B220057	E110
1" NPT	B111C-110	B111126	not required	E110

<sup>1</sup> Turbine example: see "Table 5" on page 12

<sup>2</sup> Pickup: see "Table 6" on page 12

<sup>3</sup> Monitor: see "Table 47" on page 50; Approvals see page 39



# Blancett® 1100 standard flow meters – 304 SS flange connections with B11109 magnetic pickup

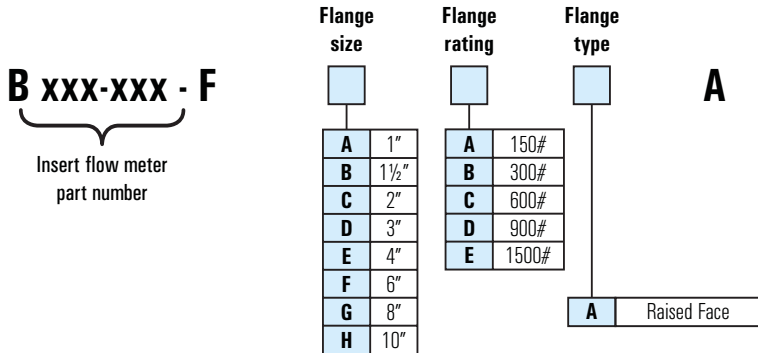

Refer to the chart on the left to select the part number for a model 1100 with flange connections. As an alternative to the model 1100 flanged meters, consider the QuikSert® models.

## Specifications

Materials of construction	Body	316 stainless steel
	Rotor	CD4MCU stainless steel
	Rotor support	316 stainless steel journal bearings
	Rotor shaft	Tungsten carbide
	Flange connections	304 stainless steel
Turndown ratio	10:1	
Flow accuracy	± 1% of reading	
Repeatability	± 0.1%	
Calibration	Water (NIST traceable calibration)	
Turbine temperature	-101 to +165 °C (-150 to +330 °F) with magnetic pickup (B111109) -101 to +232 °C (-150 to +450 °F) with high temperature pickup (B220111)	
Approvals	CSA Class I Div 1, Groups C & D   Class II Div 1, Groups E, F & G: intrinsically safe*	
	CSA Class I Div 1 Groups C,D; complies to UL 1203 and CSA 22.2 No. 30	
	Met Labs File No. E112860 (for explosion proof models only)	

## Configuration examples

Monitor			
Mounting	Turbine with magnetic pickup <sup>1</sup>	Cable <sup>2</sup>	Monitor <sup>3</sup>
Meter mounted display	B111-110-FAAAA	-	B30AM-CS
Remote mounted display (with cable)	B111-110-FAAAA	B220-220 or B220-221	B30AR-CS

<sup>1</sup> Turbine example: see "Table 7" on page 15

<sup>2</sup> Cables: see "Table 52" on page 55

<sup>3</sup> Monitor: see "Table 45" on page 49

Part number <sup>1</sup>	Meter size	End connection	Maximum pressure		Flow rate		K-factor <sup>2</sup>	
			psi	bar	gal/min	l/min	pulses/gal	pulses/liter
B111-110-FAAAA	1"	150# RF	270	18,6	5 - 50	18,9 - 189,2	870	229
B111-110-FABAA		300# RF	700	48,2				
B111-110-FACAA		600# RF	1440	99,3				
B111-110-FADAA		900# RF	2160	148,9				
B111-110-FAEAA		1500# RF	3600	248,2				
B111-115-FBAAA	1½"	150# RF	270	18,6	15 - 180	56,8 - 681,4	330	87
B111-115-FBBAA		300# RF	700	48,2				
B111-115-FBCAA		600# RF	1440	99,3				
B111-115-FBDAA		900# RF	2160	148,9				
B111-115-FBEAA		1500# RF	3600	248,2				
B111-121-FCAAA	2" LF	150# RF	270	18,6	15 - 180	56,8 - 681,4	330	87
B111-121-FCBAA		300# RF	700	48,2				
B111-121-FCCAA		600# RF	1440	99,3				
B111-121-FCDAA		900# RF	2160	148,9				
B111-121-FCEAA		1500# RF	3600	248,2				
B111-120-FCAAA	2"	150# RF	270	18,6	40 - 400	151,4 - 1514,2	52	13
B111-120-FCBAA		300# RF	700	48,2				
B111-120-FCCAA		600# RF	1440	99,3				
B111-120-FCDAA		900# RF	2160	148,9				
B111-120-FCEAA		1500# RF	3600	248,2				
B111-130-FDAAA	3"	150# RF	270	18,6	60 - 600	227,2 - 2271,2	57	15
B111-130-FDBAA		300# RF	700	48,2				
B111-130-FDCAA		600# RF	1440	99,3				
B111-130-FDDAA		900# RF	2160	148,9				
B111-130-FDEAA		1500# RF	3600	248,2				
B111-140-FAAAA	4"	150# RF	270	18,6	100 - 1200	378,5 - 4542,5	29	7,6
B111-140-FEBAA		300# RF	700	48,2				
B111-140-FECAA		600# RF	1440	99,3				
B111-140-FEDAA		900# RF	2160	148,9				
B111-140-FEEAA		1500# RF	3600	248,2				
B111-160-FAAAA	6"	150# RF	270	18,6	200 - 2500	757- 9463,5	7	1,8
B111-160-FBAAA		300# RF	700	48,2				
B111-160-FFCAA		600# RF	1440	99,3				
B111-160-FFDAA		900# RF	2160	148,9				
B111-160-FFEAA		1500# RF	3600	248,2				
B111-180-FGAAA	8"	150# RF	270	18,6	250 - 3500	946,4 - 13249	3	0,8
B111-180-FGBAA		300# RF	700	48,2				
B111-180-FGCCAA		600# RF	1440	99,3				
B111-180-FGDAA		900# RF	2160	148,9				
B111-180-FGEAA		1500# RF	3600	248,2				
B111-200-FHAAA	10"	150# RF	270	18,6	500 - 5000	1892,7 - 18927	2	0,5
B111-200-FHBAA		300# RF	700	48,2				
B111-200-FHCAA		600# RF	1440	99,3				
B111-200-FHDAA		900# RF	2160	148,9				
B111-200-FHEAA		1500# RF	3600	248,2				

<sup>1</sup> Includes standard magnetic pickup, p/n B111109, -101 to +165 °C (-150 to +330 °F), suitable for all mounting styles.

<sup>2</sup> All K-factors are approximate.

# Blancett® 1100 explosion proof flow meters – 304 SS flange connections without magnetic pickup

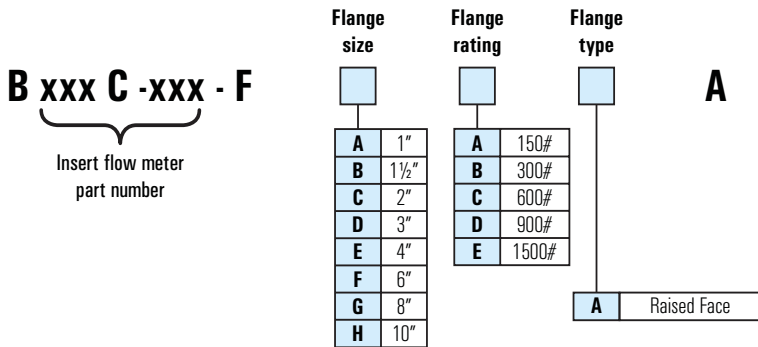

Refer to the chart on the left to select the part number for a model 1100 with flange connections. As an alternative to the model 1100 flanged meters, consider the QuikSert® models.

## Model 1100 explosion proof pickup options

Part number	Magnetic pickup	Temperature range
B111109	Standard	-101 °C to +165 °C (-150 °F to 330 °F)
B111126	ATEX $\text{Ex}$ II 1G; EEx ia IIC T5	-50 °C to +120 °C (-58 °F to 248 °F)
B220243	Intrinsically safe, FM rated	-101 °C to +165 °C (-150 °F to 330 °F)

Table 8

## Configuration examples

For hazardous location – Explosion proof				
Mounting	Turbine <sup>1</sup> (no pickup)	Magnetic pickup <sup>2</sup>	Explosion proof meter mount kit	Explosion proof monitor <sup>3</sup>
Remote mount	B111C-140-FEAAA	B111109	B280-737	B30XR-CS

<sup>1</sup> Turbine example: see "Table 9" on page 17;

<sup>2</sup> Pickups: see "Table 8" on page 16

<sup>3</sup> Monitors: see "Table 45" on page 49; Approvals see page 48

For hazardous location – Intrinsically safe					
Mounting	Turbine <sup>1</sup> (no pickup)	Magnetic pickup <sup>2</sup>	Cable <sup>3</sup>	In non hazardous location	Explosion proof monitor <sup>4</sup>
Remote mounted	B111C-140-FEAAA	B111126	B220-220 or B220-221	I.S. barrier and display	B30XR-CS
Remote mounted	B111C-140-FEAAA	B220243	B220-220 or B220-221	I.S. barrier and display	–

<sup>1</sup> Turbine example: "Table 9" on page 17;

<sup>2</sup> Pickups: see "Table 8" on page 16

<sup>3</sup> Cables: see "Table 52" on page 55

<sup>4</sup> Monitors: see "Table 45" on page 49; Approvals see page 48

I.S. barrier not available

ATEX				
Mounting	Turbine (no pickup) <sup>1</sup>	Magnetic pickup <sup>2</sup>	Bushing reducer	ATEX monitor <sup>3</sup>
Meter mounted	B111C-140-FEAAA	B111126	B220056 or B220057	E110

<sup>1</sup> Turbine example: see "Table 9" on page 17

<sup>2</sup> Pickup: see "Table 8" on page 16

<sup>3</sup> Monitors: see "Table 47" on page 50; Approvals see page 39

Part number <sup>1</sup>	Meter size	End connection	Maximum pressure		Flow rate		K-factor <sup>2</sup>	
			psi	bar	gal/min	l/min	pulses/gal	pulses/liter
B111C-110-FAAAA	1"	150# RF	270	18,6	5 - 50	18,9 - 189,2	870	229
B111C-110-FABAA		300# RF	700	48,2				
B111C-110-FACAA		600# RF	1440	99,3				
B111C-110-FADAA		900# RF	2160	148,9				
B111C-110-FAEAA		1500# RF	3600	248,2				
B111C-115-FBAAA	1½"	150# RF	270	18,6	15 - 180	56,8 - 681,4	330	87
B111C-115-FBBAA		300# RF	700	48,2				
B111C-115-FBCAA		600# RF	1440	99,3				
B111C-115-FBDAA		900# RF	2160	148,9				
B111C-115-FBEAA		1500# RF	3600	248,2				
B111C-121-FCAAA	2" LF	150# RF	270	18,6	15 - 180	56,8 - 681,4	330	87
B111C-121-FCBAA		300# RF	700	48,2				
B111C-121-FCCAA		600# RF	1440	99,3				
B111C-121-FCDAA		900# RF	2160	148,9				
B111C-121-FCEAA		1500# RF	3600	248,2				
B111C-120-FCAAA	2"	150# RF	270	18,6	40 - 400	151,4 - 1514,2	52	13
B111C-120-FCBAA		300# RF	700	48,2				
B111C-120-FCCAA		600# RF	1440	99,3				
B111C-120-FCDAA		900# RF	2160	148,9				
B111C-120-FCEAA		1500# RF	3600	248,2				
B111C-130-FDAAA	3"	150# RF	270	18,6	60 - 600	227,2 - 2271,2	57	15
B111C-130-FDBAA		300# RF	700	48,2				
B111C-130-FDCAA		600# RF	1440	99,3				
B111C-130-FDDAA		900# RF	2160	148,9				
B111C-130-FDEAA		1500# RF	3600	248,2				
B111C-140-FEAAA	4"	150# RF	270	18,6	100 - 1200	378,5 - 4542,5	29	7,6
B111C-140-FEBAA		300# RF	700	48,2				
B111C-140-FECAA		600# RF	1440	99,3				
B111C-140-FEDAA		900# RF	2160	148,9				
B111C-140-FEEAA		1500# RF	3600	248,2				
B111C-160-FFAAA	6"	150# RF	270	18,6	200 - 2500	757- 9463,5	7	1,8
B111C-160-FFBAA		300# RF	700	48,2				
B111C-160-FFCAA		600# RF	1440	99,3				
B111C-160-FFDAA		900# RF	2160	148,9				
B111C-160-FFEAA		1500# RF	3600	248,2				
B111C-180-FGAAA	8"	150# RF	270	18,6	250 - 3500	946,4 - 13249	3	0,8
B111C-180-FGBAA		300# RF	700	48,2				
B111C-180-FGCAA		600# RF	1440	99,3				
B111C-180-FGDAA		900# RF	2160	148,9				
B111C-180-FGEAA		1500# RF	3600	248,2				
B111C-200-FHAAA	10"	150# RF	270	18,6	500 - 5000	1892,7 - 18927	2	0,5
B111C-200-FHBAA		300# RF	700	48,2				
B111C-200-FHCAA		600# RF	1440	99,3				
B111C-200-FHDAA		900# RF	2160	148,9				
B111C-200-FHEAA		1500# RF	3600	248,2				

**Approvals:** CSA Class I Div 1, Groups C & D; Class II Div 1, Groups E, F & G: intrinsically safe; CSA Class I Div 1 Groups C, D; complies to UL 1203 and CSA 22.2 N° 30; Met Labs File No. E112860

<sup>1</sup> Requires purchase of separate pickup, see "Table 8" on page 16 for available options.

<sup>2</sup> All K-factors are approximate.

## Blancett® 1100 nickel bindery flow meters – for aggressive applications with B11109 magnetic pickup

### Specifications

Materials of construction	Body	316 stainless steel
	Rotor	CD4MCU stainless steel nickel plated
	Rotor support	Nickel bindery tungsten carbide
	Rotor shaft	Tungsten carbide
Turndown ratio	10:1	
Flow accuracy	± 1% of reading for 7/8" and larger meters ± 1% of reading over the upper 70% of the measuring range for 3/8", 1/2" and 3/4" meter size	
Repeatability	± 0.1%	
Calibration	Water (NIST traceable calibration)	
Turbine temperature	-101 up to + 165 °C (-150 up to + 330 °F) with magnetic pickup (B111109) -101 up to + 232 °C (-150 up to + 450 °F) with high temperature pickup (B220111)	

Part number <sup>1</sup>	Meter size	Hub size	End connection	Maximum pressure	Flow rate		K-factor <sup>2</sup>	
					gal/min	l/min	pulses/gal	pulses/liter
B111-700-1/2	3/8"	1/2"	1/2" × 1/2" male NPT	345 bar (5000 psi)	0,6 - 3	2,3 - 11,4	18000	4749
B111-701-1/2	1/2"				0,75 - 7,5	2,8 - 28,4	13000	3430
B111-702-1/2	3/4"				2 - 15	7,6 - 56,8	3300	870
B111-700	3/8"	1"	1" × 1" male NPT		0,6 - 3	2,3 - 11,4	18000	4749
B111-701	1/2"				0,75 - 7,5	2,8 - 28,4	13000	3430
B111-702	3/4"				2 - 15	7,6 - 56,8	3300	870
B111-703	7/8"				3 - 30	11,4 - 113,6	3100	818
B111-704	1"				5 - 50	18,9 - 189,2	870	229
B111-705	1 1/2"				1 1/2" × 1 1/2" male NPT	5 - 50	18,9 - 189,2	330
B111-707	1 1/2"			2" × 2" male NPT	15 - 180	56,8 - 681,4	330	87
B111-706	2"	2" × 2" female NPT	40 - 400	151,4 - 1514,2	52	13		

<sup>1</sup> Includes standard magnetic pickup, p/n B111109, -101 to + 165 °C (-150 to + 330 °F), suitable for all mounting styles.

<sup>2</sup> All K-factors are approximate.

Table 10

## Blancett® CS-1100 flow meters – for cement slurries with B11109 magnetic pickup

### Specifications

Materials of construction	Body	316 stainless steel
	Rotor	CD4MCU stainless steel nickel plated
	Rotor support	Nickel bindery tungsten carbide
	Rotor shaft	Tungsten carbide
Turndown ratio	10:1	
Flow accuracy	±4% of reading	
Repeatability	±0.1%	
Calibration	Water (NIST traceable calibration)	
Turbine temperature	-101 up to +165 °C (-150 up to +330 °F) with magnetic pickup (B111109) -101 up to +232 °C (-150 up to +450 °F) with high temperature pickup (B220111)	

Part number <sup>1</sup>	Meter size	End connection	Maximum pressure	Flow rate		K-factor <sup>2</sup>	
				gal/min	l/min	pulses/gal	pulses/liter
B111-503	3/8"	1" × 1" male NPT	345 bar (5000 psi)	0,6 - 3	2,3 - 11,4	9000	2375
B111-505	½"			0,75 - 7,5	2,8 - 28,4	6500	1715
B111-507	¾"			2 - 15	7,6 - 56,8	1650	435
B111-508	7/8"			3 - 30	11,4 - 113,6	1550	396
B111-510	1"			5 - 50	18,9 - 189,2	435	115
B111-515	1½"			1½" × 1½" male NPT	15 - 180	56,8 - 681,4	165
B111-521	1½"	2" × 2" male NPT	15 - 180	56,8 - 681,4	165	44	
B111-520	2"	2" × 2" female NPT	40 - 400	151,4 - 1514,2	26	6,8	
B111-530	3"	Grooved end	55 bar (800 psi)	60 - 600	227,2 - 2271,2	28,5	7,5
B111-540	4"			100 - 1200	378,5 - 4542,5	14,5	3,8
B111-560	6"			200 - 2500	757,0 - 9463,5	3,5	0,9
B111-580	8"			250 - 3500	946,4 - 13249	1,5	0,4

<sup>1</sup> Includes standard magnetic pickup, p/n B111109, -101 to +165 °C (-150 to +330 °F), suitable for all mounting styles.

<sup>2</sup> All K-factors are approximate.

NOTE: Flanged fittings available upon request - consult factory for price and availability.

Table 11

# Blancett® model 1200



- 1/4" to 3/4" size available
- Simple installation

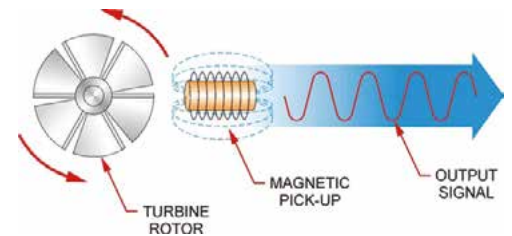

Illustration of electrical signal generated by rotor movement

## Blancett® 1200 turbine flow meter

The model 1200 turbine flow meter has been designed for high corrosive environments. Developed for use in petrochemical and process

industries with liquid chemical flows, the model 1200 turbine provides accuracy and durability in aggressive industrial environments.

## Specifications

Materials of construction	Body	303 stainless steel
	Rotor	CD4MCU stainless steel
	Bearings	Two (2) type-440 stainless steel ball bearings
	Rotor support and shaft	303 stainless steel
Operating parameters	Meter	-51 up to +177 °C (-60 up to +350 °F)
	RF pickup	-101 up to +162 °C (-150 up to +325 °F)
	Pressure	276 bar (4000 psi) maximum
	Accuracy	± 1.0% of reading
	Repeatability	± 0.1%
	Calibration	Water (NIST traceable calibration)
RF preamplifier	Input signal	1 millihenry carrier pickup
	Output signal	10V peak to peak square wave
Temperature	Module	-7 up to +71 °C (-20 up to +160 °F)
	Power	7 – 30V DC
	Distance specification	15,2 m (50 ft) maximum between pickup and RF preamplifier 305 m (1000 ft) maximum between preamplifier and receiving unit
	Electrical connection	Terminal strip
	Housing	Epoxy encapsulated module

## Blancett® 1200 turbine flow meters for highly corrosive environments – with B11117 RF pickup and preamplifier

Part number <sup>1</sup>	Bore size	End connection	Maximum pressure	Flow rate		K-factor <sup>2</sup>	
				gal/min	l/min	pulses/gal	pulses/liter
B121-225	¼"	½" male NPT	276 bar (4000 psi)	0,25 - 2,5	0,95 - 9,5	29000 - 33000	7651 - 8707
B121-250	½"	½" female NPT		0,75 - 7,5	2,84 - 28,4	8500 - 9500	2243 - 2507
B121-275	¾"	1" male NPT		2,5 - 25	9,5 - 94,6	2800 - 3000	739 - 792

<sup>1</sup> Includes B111117 RF pickup, PN 1200003, 10 ft Teflon cable assembly with 90 °Connector, and 12/24 VDC Preamplifier, PN B222228.

Table 12

<sup>2</sup> All K-factors are approximate.

### RF Pickup B111117 with preamplifier B222228

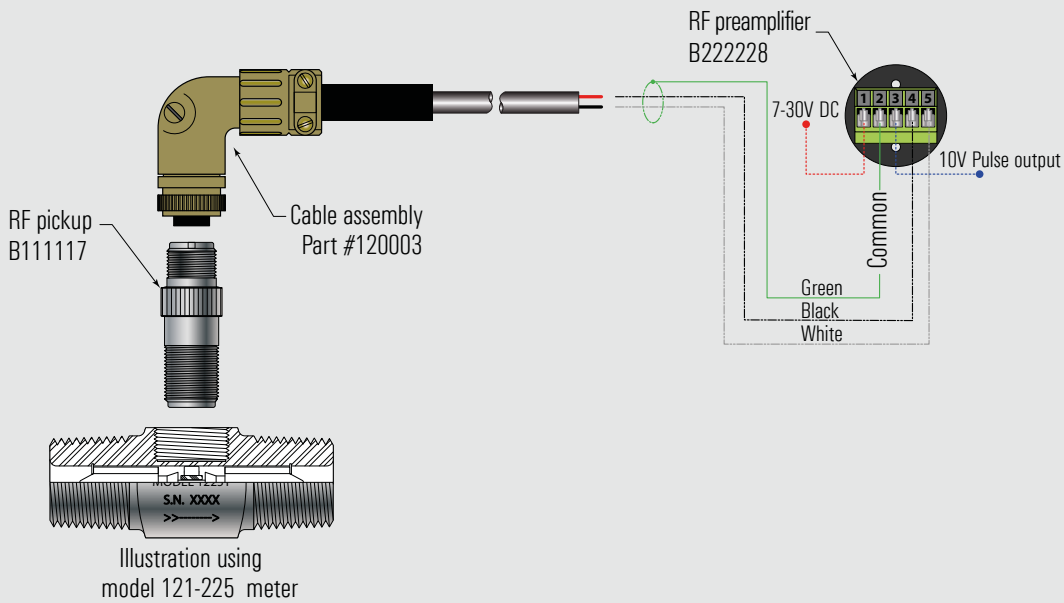

Wiring diagram with RF pickup, cable assembly and preamplifier

Terminal	Description	Notes
1	Power	7-30V DC
2	Common	Power return
3	Output signal	10V square wave
4	Input	RF pickup (1 millihenry)
5	Input	RF pickup (1 millihenry)



## Blancett® 1200 turbine flow meters – without magnetic pickup

Part number	Bore size	End connection	Maximum pressure	Flow rate		K-factor <sup>1</sup>	
				gal/min	l/min	pulses/gal	pulses/liter
B121227	¼"	½" male NPT	276 bar (4000 psi)	0,25 - 2,5	0,95 - 9,5	29000 - 33000	7651 - 8707
B121251	½"	½" female NPT		0,75 - 7,5	2,84 - 28,4	8500 - 9500	2243 - 2507
B121276	¾"	1" male NPT		2,5 - 25	9,5 - 94,6	2800 - 3000	739 - 792

<sup>1</sup> All K-factors are approximate.

Table 13

## Blancett® 1200 turbine flow meters – pickup options

Part number	Magnetic pickup
B111117	Standard RF pickup -101 °C to +165 °C (-150 °F to +330 °F) for 1200, CorrExx™ series only
B120101	Magnetic pickup, all stainless steel, long nose for 1200, CorrExx™ series only
B140013	Shielded magnetic pickup, stainless steel for 1200, CorrExx™ series only

Table 14

## Configuration examples

Monitor				
Mounting	Turbine <sup>1</sup>	Magnetic pickup <sup>2</sup>	Cable <sup>3</sup>	Monitor <sup>4</sup>
Remote mounted display	B121227	B120101	B220-220	B30AR-CS

<sup>1</sup> Turbine example: see "Table 13" on page 22

<sup>2</sup> Pickup: see "Table 14" on page 22

<sup>3</sup> Cable: see "Table 52" on page 55

<sup>4</sup> Monitors: see "Table 45" on page 49

# Blancett® model 1500



Blancett® 1500  
with meter mounted  
B3000 display

- Extraordinary linearity
- High measuring accuracy
- Available in sizes from 1/4" to 2"
- Available with 10 point calibration certificate

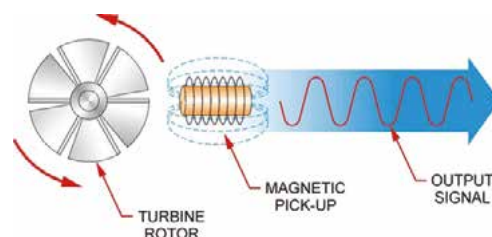

Illustration of electrical signal generated by rotor movement

## Blancett® turbine meter model 1500

Blancett® 1500 flow meters are the ideal solutions for standard clean, filtered liquid flow applications in precision industrial processes, found in the automotive, chemical/petrochemical, aerospace and general industries.

Turbine flow meters 1500 have exceptional mechanical linearity, resulting in minimizing

or negating temperature induced viscosity influence. Meters come with national pipe thread (NPT) or flange process fittings, sizes up to two inches and can be ordered with a Blancett® B3000 flow monitor to accommodate the requirements of most applications and flow ranges.

## Specifications

Materials of construction	Body	316 stainless steel
	Shafts	316 stainless steel
	Rotors	17-4 PH stainless steel
	Bearing	Ceramic ball bearings
Operating parameters	Meter	-101 °C up to +149 °C (-150 °F up to +300 °F)
	Pickup	-101 °C up to +149 °C (-150 °F up to +300 °F) / B111113
	Pressure	max. 408 bar
	Accuracy	± 0,5% of reading; ± 0,25 with monitor and linearisation
	Repeatability	± 0,02% of reading
	Response time	2 – 3 ms (at 1.2 cSt)
	Calibration	Solvent (NIST traceable calibration); 10-point calibration

## Blancett® 1500 turbine flow meters – with B11113 magnetic pickup

Part number <sup>1</sup>	Bore size	End connection	Maximum pressure		Flow rate		K-factor <sup>2</sup>	
			psi	bar	gal/min	l/min	pulses/gal	pulses/liter
B150-501-NPT	¼"	½" NPT	5922	408	0,25 - 2,5	0,9 - 9,5	28800	7599
B150-502-NPT	3/8"		4700	324	0,50 - 5,0	2,8 - 28,4	14400	3799
B150-503-NPT	½"		4418	304	0,75 - 7,50	9,5 - 94,6	9600	2533
B150-625-NPT	5/8"	¾" NPT	4136	285	1,25 - 12,5	4,7 - 47,3	5760	1520
B150-750-NPT	¾"		4136	285	2,5 - 25,0	9,5 - 94,6	2800	739
B150-110-NPT	1"	1" NPT	4042	279	5,00 - 50,0	18,9 - 189,3	1440	380
B150-125-NPT	1 ¼"	1-1/4" NPT	4700	324	7,50 - 75,0	28,4 - 283,9	960	253
B150-115-NPT	1 ½"	1-½" NPT	4230	292	12,5 - 125	47,3 - 473,2	576	152
B150-120-NPT	2"	2" NPT	3666	253	25,0 - 250	94,6 - 946,4	288	76
B150-501-F15	¼"	½" 150# Flange	275	19	0,25 - 2,5	0,9 - 9,5	28800	7599
B150-502-F15	3/8"				0,50 - 5,00	2,8 - 28,4	14400	3799
B150-503-F15	½"				0,75 - 7,50	9,5 - 94,6	9600	2533
B150-625-F15	5/8"	¾" 150# Flange	275	19	1,25 - 12,5	4,7 - 47,3	5760	1520
B150-750-F15	¾"				2,5 - 25,0	9,5 - 94,6	2800	739
B150-110-F15	1"	1" 150# Flange	275	19	5,00 - 50,0	18,9 - 189,3	1440	380
B150-125-F15	1 ¼"	1-1/4" 150# Flange			7,50 - 75,0	28,4 - 283,9	960	253
B150-115-F15	1 ½"	1-½" 150# Flange			12,5 - 125	47,3 - 473,2	576	152
B150-120-F15	2"	2" 150# Flange	275	19	25,0 - 250	94,6 - 946,4	288	76

<sup>1</sup> Includes standard magnetic pickup part number B111113.

<sup>2</sup> K-factor will vary meter to meter. Refer to the calibration test report.

Table 15

### NPT meter pressure rating

1. Pressure ratings are for temperatures up to 37.8 °C (100 °F).
2. Pressure rating is calculated with an allowable stress value of 1379 bar (20,000 psi) for 316 SS per pressure piping code ASME B31.3
3. Pressure chart is displaying safe working pressure, in accordance with power piping code ASME B31.1

### Flange meter pressure rating

1. Specifications from maximum non-shock allowable working pressure in PSIG at 37.8 °C (100 °F) or less.
2. Stainless steel 316A-181 material.
3. Pressure rating in accordance with ASME B16.5 standards.

## Configuration examples

Monitor			
Mounting	Turbine with magnetic pickup <sup>1</sup>	Cable	Monitor <sup>2</sup>
Meter mounted display	B150-110-NPT	-	B30AM-CS
Remote mounted display (with cable)	B150-110-NPT	B220-220 or B220-B221	B30AR-CS

<sup>1</sup> Turbine example: see "Table 15" on page 24

<sup>2</sup> Monitors: see "Table 45" on page 49 (adapter to mount the monitor on the meter will be provided when ordering as system)

NOTE: Hazardous location not available

NOTE: Hazardous location - intrinsically safe not available (B111126 is not suitable)

### F to I intelligent converter

Turbine with magnetic pickup <sup>1</sup>	F to I intelligent converter <sup>2</sup>	Programming kit
B150-501-NPT	B 220-873	B220-954

<sup>1</sup> Turbine example: see "Table 15" on page 24

<sup>2</sup> F to I converter: see "Table 49" on page 54

### F to V intelligent converter

Turbine with magnetic pickup <sup>1</sup>	F to V intelligent converter <sup>2</sup>	Programming kit
B150-501-NPT	B220-874	B220-954

<sup>1</sup> Turbine example: see "Table 15" on page 24

<sup>2</sup> F to V converter: see "Table 49" on page 54



# Blancett® QuikSert® turbine flow meters

## – Liquids



- No need for mating flanges
- CSA explosion proof models available
- NIST traceable calibration
- Easy installation
- Lower maintenance costs

### Turbine meters for harsh applications

The QuikSert® turbine flow meter's durable stainless steel body incorporates a helical turbine with tungsten carbide shaft and bearings. The meter provides an efficient, long service life and a cost effective solution for your measurement requirements. The QuikSert's compact design requires less space in the flow line, allowing

easy installation and lower mechanical costs. The QuikSert® utilizes modified upstream and downstream flow straighteners for enhanced fluid dynamics. QuikSert® provides a local flow rate and volume totalization when used with a Blancett® monitor.

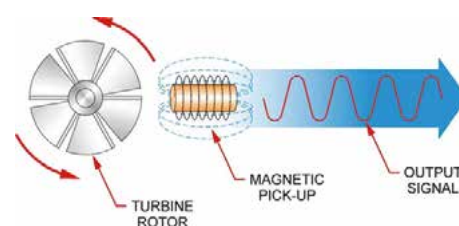

Illustration of electrical signal generated by rotor movement

### Specifications

Materials of construction	Body and internal wetted parts	316L stainless steel
	Turbine	CD4MCU stainless steel
	Bearings	Tungsten carbide
	Shaft	Tungsten carbide
Accuracy	± 1% of reading for 7/8" and larger meters ± 1% of reading over the upper 70% of the measuring range for 3/8", 1/2" and 3/4" meters	
Repeatability	± 0.1%	
Calibration	Water (NIST traceable calibration)	
pressure rating	See pressure rating table below	
Operating temperature	-101 °C up to +177 °C (-150 up to +350 °F) with standard magnetic pickup (B111109) -26 °C up to +232 °C (-15 up to +450 °F) with high-temp pickup (B220111)	
End connections	Wafer-style ASME/ANSI B16.5-1996	
Approvals	For explosion proof models only: Class I Div 1 Groups C,D; complies to UL 1203 and CSA 22.2 No. 30 Met Labs File No. E112860	

### Pressure rating

Flange class (ANSI)	150	300	600	900	1500
Working pressure (psi)	285	740	1480	2220	3705
Working pressure (bar)	19,6	51	102	153	255,5
Working pressure (MPa)	1,97	5,10	10,20	15,31	25,55
* Test pressure (psi)	427,5	1110	2220	3330	5557,5
* Test pressure (MPa)	2,95	7,65	15,31	22,98	38,32

The pressure rating of the meter is dependent upon the class of ANSI flanges between which the meter is to be mounted. The pressure rating chart is based on Carbon steel at 37,8 °C (100 °F).

\*Test pressure based on 1,5 safety factor.

## Blancett® QuikSert® turbine flow meter – with B11109 magnetic pickup

Part number <sup>1</sup>	Bore x line size	Maximum pressure drop		Flow rate		K-factor <sup>2</sup>		Dimensions diameter x length	
		psi	bar	gal/min	l/min	pulses/gal	pulses/liter	inches	mm
B131-038	3/8" x 1"	3,75	0,26	0,6 - 3	2,3 - 11,4	18000	4749	2 x 4	50,8 x 101,6
B131-050	1/2" x 1"	6,5	0,45	0,75 - 7,5	2,8 - 28,4	13000	3430	2 x 4	50,8 x 101,6
B131-075	3/4" x 1"	18	1,24	2 - 15	7,6 - 56,8	3300	871	2 x 4	50,8 x 101,6
B131-088	7/8" x 1"	20	1,38	3 - 30	11,4 - 113,6	3100	818	2 x 4	50,8 x 101,6
B131-100	1" x 1"	20	1,38	5 - 50	18,9 - 189,2	870	230	2 x 4	50,8 x 101,6
B132-050	1/2" x 2"	12	0,83	0,75 - 7,5	2,8 - 28,4	13000	3430	3,62 x 2,5	91,5 x 63,5
B132-075	3/4" x 2"	18	1,24	2 - 15	7,6 - 56,8	3300	871	3,62 x 2,5	91,5 x 63,5
B132-088	7/8" x 2"	20	1,38	3 - 30	11,4 - 113,6	3100	818	3,62 x 2,5	91,5 x 63,5
B132-100	1" x 2"	20	1,38	5 - 50	18,9 - 189,2	870	230	3,62 x 2,5	91,5 x 63,5
B132-150	1 1/2" x 2"	16	1,10	15 - 180	56,8 - 681,4	330	87	3,62 x 2,5	91,5 x 63,5
B132-200	2" x 2"	9	0,62	40 - 400	151,4 - 1514,2	52	13,7	3,62 x 2,5	91,5 x 63,5
B132-250	2" x 3"	10	0,69	40 - 400	151,4 - 1514,2	52	13,7	3,62 x 4,25	91,5 x 108
B133-300	3" x 3"	10	0,69	60 - 600	227,2 - 2271,2	57	15	5 x 4,25	127 x 108
B133-380	3" x 3"	10	0,69	80 - 800	302,8 - 3028,3	57	15	5 x 4,25	127 x 108
B134-400	4" x 4"	10	0,69	100 - 1200	378,5 - 4542,5	29	7,7	6,18 x 5	157 x 127
B136-600	6" x 6"	10	0,69	200 - 2500	757,0 - 9463,5	7	1,8	8,5 x 5,75	216 x 146
B138-800	8" x 8"	10	0,69	350 - 3500	1324,9 - 13249	3	0,8	10,62 x 6,25	269,7 x 159
B139-900	10" x 10"	10	0,69	500 - 5000	1892,7 - 18927	1,6	0,4	12,75 x 6,75	323,9 x 171,5

<sup>1</sup> Includes standard magnetic pickup, p/n B111109, -101 to +165 °C (-150 to +330 °F), suitable for all mounting styles.

<sup>2</sup> All K-factors are approximate.

Table 16

## Configuration examples

Monitor			
Mounting	Turbine with magnetic pickup <sup>1</sup>	Monitor <sup>2</sup>	Cable <sup>3</sup>
Meter mounted display	B131-100	B30AM-CS	-
Remote mounted display (with cable)	B131-100	B30AR-CS	B220-220 or B220-221

<sup>1</sup> Turbine example: see "Table 16" on page 26

<sup>2</sup> Monitors: see "Table 45" on page 49

<sup>3</sup> Cables: see "Table 52" on page 55

## Blancett® QuikSert® explosion proof flow meter for hazardous locations – without magnetic pickup

Part number	Bore x line size	Maximum pressure drop		Flow rate		K-factor <sup>1</sup>		Dimensions Dia. x length	
		psi	bar	gal/min	l/min	pulses/gal	pulses/liter	inches	mm
B131C-038	3/8" x 1"	3,75	0,26	0,6 - 3	2,3 - 11,4	18000	4749	2 x 4	50,8 x 101,6
B131C-050	1/2" x 1"	6,5	0,45	0,75 - 7,5	2,8 - 28,4	13000	3430	2 x 4	50,8 x 101,6
B131C-075	3/4" x 1"	18	1,24	2 - 15	7,6 - 56,8	3300	871	2 x 4	50,8 x 101,6
B131C-088	7/8" x 1"	20	1,38	3 - 30	11,4 - 113,6	3100	818	2 x 4	50,8 x 101,6
B131C-100	1" x 1"	20	1,38	5 - 50	18,9 - 189,2	870	230	2 x 4	50,8 x 101,6
B132C-050	1/2" x 2"	12	0,83	0,75 - 7,5	2,8 - 28,4	13000	3430	3,62 x 2,5	91,5 x 63,5
B132C-075	3/4" x 2"	18	1,24	2 - 15	7,6 - 56,8	3300	871	3,62 x 2,5	91,5 x 63,5
B132C-088	7/8" x 2"	20	1,38	3 - 30	11,4 - 113,6	3100	818	3,62 x 2,5	91,5 x 63,5
B132C-100	1" x 2"	20	1,38	5 - 50	18,9 - 189,2	870	230	3,62 x 2,5	91,5 x 63,5
B132C-150	1 1/2" x 2"	16	1,10	15 - 180	56,8 - 681,4	330	87	3,62 x 2,5	91,5 x 63,5
B132C-200	2" x 2"	9	0,62	40 - 400	151,4 - 1514,2	52	13,7	3,62 x 2,5	91,5 x 63,5
B132C-250	2" x 3"	10	0,69	40 - 400	151,4 - 1514,2	52	13,7	3,62 x 4,25	91,5 x 108
B133C-300	3" x 3"	10	0,69	60 - 600	227,2 - 2271,2	57	15	5 x 4,25	127 x 108
B133C-380	3" x 3"	10	0,69	80 - 800	302,8 - 3028,3	57	15	5 x 4,25	127 x 108
B134C-400	4" x 4"	10	0,69	100 - 1200	378,5 - 4542,5	29	7,7	6,18 x 5	157 x 127
B136C-600	6" x 6"	10	0,69	200 - 2500	757,0 - 9463,5	7	1,8	8,5 x 5,75	216 x 146
B138C-800	8" x 8"	10	0,69	350 - 3500	1324,9 - 13249	3	0,8	10,62 x 6,25	269,7 x 159
B139C-900	10" x 10"	10	0,69	500 - 5000	1892,7 - 18927	1.6	0,4	12,75 x 6,75	323,9 x 171,5

**Approvals:** Class I Div 1 Groups C,D; complies to UL 1203 and CSA 22.2 No. 30; Met Labs File No. E112860

<sup>1</sup> All K-factors are approximate.

Table 17

## Blancett® QuikSert® pickup options

Part number	Magnetic pickup	Temperature Range
B111109	Standard	-101 – 165 °C (-150 – 330 °F)
B111126	ATEX  II 1G; EEx ia IIC T5	-50 – 120 °C (-58 – 248 °F)
B220111	High temperature	-26 – 232 °C (-450 – 450 °F)
B220210	With preamplifier	-40 – 121 °C (-40 – 250 °F)
B220243	Intrinsically safe, FM rated	-40 – 21 °C (-40 – 250 °F)

Table 18

## Configuration examples

### For hazardous location – Explosion proof

Turbine (no pickup) <sup>1</sup>	Magnetic pickup	Explosion proof meter mount kit	Explosion proof monitor <sup>2</sup>
B131C-100	B111109	B280-737	B30XR-CS

<sup>1</sup> Turbine example: see "Table 17" on page 27

<sup>2</sup> Monitors: see "Table 45" on page 49; Approvals see page 48

### For hazardous location – Intrinsically safe

Turbine (no pickup) <sup>1</sup>	Magnetic pickup	Cable	In non hazardous location	Explosion proof monitor <sup>2</sup>
B131C-100	B111126	B220-220 or B220-221	I.S. barrier and display	B30XR-CS
B131C-100	B220243	B220-220 or B220-221	I.S. barrier and display	B30XR-CS

<sup>1</sup> Turbine example: see "Table 17" on page 27

<sup>2</sup> Monitors: see "Table 45" on page 49; Approvals see page 48  
I.S. barrier not available

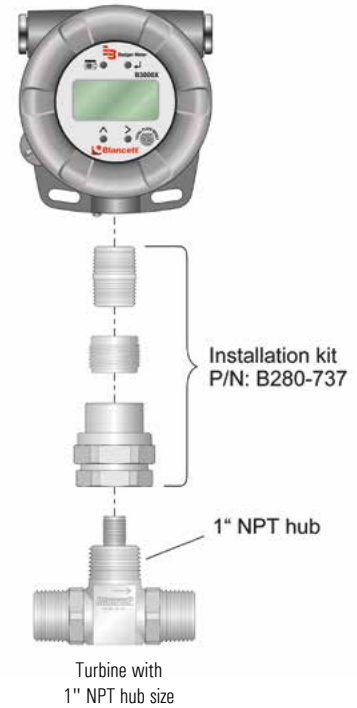

### ATEX

Turbine (no pickup) <sup>1</sup>	Magnetic pickup	ATEX monitor <sup>2</sup>
B131C-100	B111126	E110

<sup>1</sup> Turbine example: see "Table 17" on page 27

<sup>2</sup> Monitor: see "Table 47" on page 50; Approvals see page 39

## Wiring example for B111126

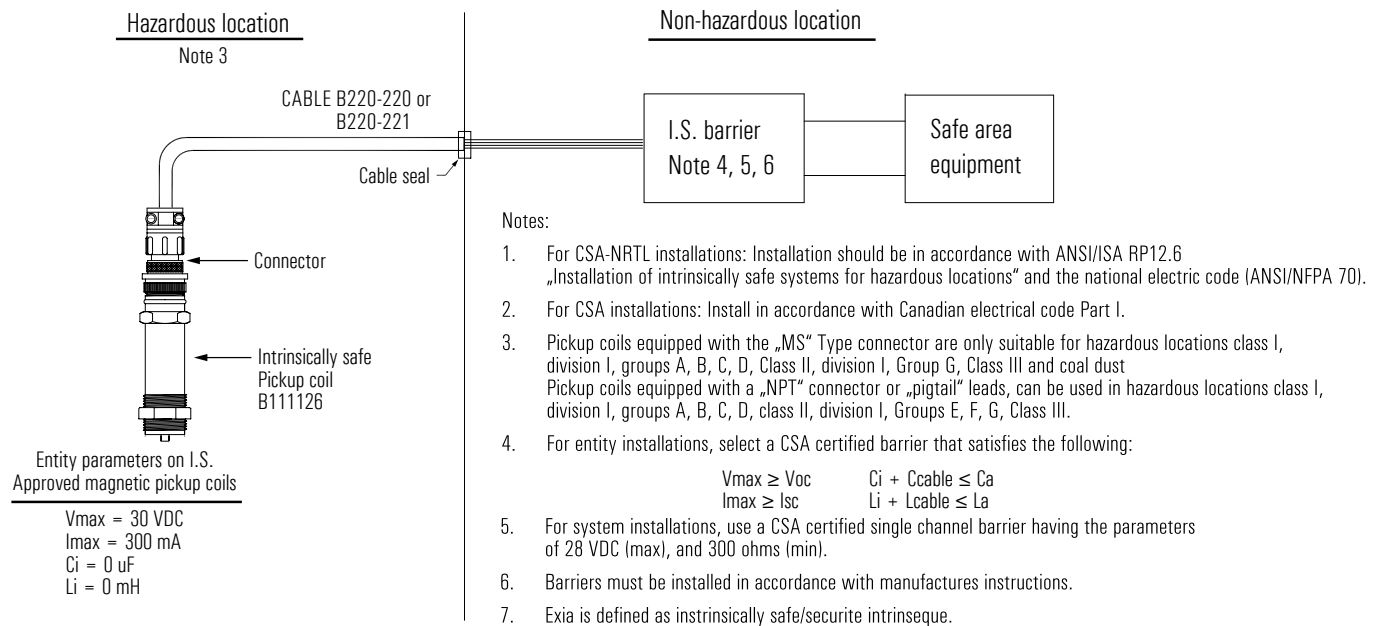

## Blancett® QuikSert® turbine flow meter for cement slurries – with B11109 magnetic pickup

Part number <sup>1</sup>	Bore x line size	Maximum pressure drop		Flow rate		K-factor <sup>2</sup>	
		psi	bar	gal/min	l/min	pulses/gal	pulses/liter
B131-503	3/8" × 1"	3,75	0,26	0,6 - 3	2,3 - 11,4	9000	2375
B131-505	1/2" × 1"	6,5	0,45	0,75 - 7,5	2,8 - 28,4	6500	1715
B131-507	3/4" × 1"	18	1,24	2 - 15	7,6 - 56,8	1650	435
B131-508	7/8" × 1"	20	1,38	3 - 30	11,4 - 113,6	1550	409
B131-510	1" × 1"	20	1,38	5 - 50	18,9 - 189,2	435	115
B132-505	1/2" × 2"	12	0,83	0,75 - 7,5	2,8 - 28,4	6500	1715
B132-507	3/4" × 2"	18	1,24	2 - 15	7,6 - 56,8	1650	435
B132-508	7/8" × 2"	20	1,38	3 - 30	11,4 - 113,6	1550	409
B132-510	1" × 2"	20	1,38	5 - 50	18,9 - 189,2	435	115
B132-515	1 1/2" × 2"	16	1,10	15 - 180	56,8 - 681,4	165	44
B132-520	2" × 2"	9	0,62	40 - 400	151,4 - 1514,2	26	6,9
B133-530	3" × 3"	10	0,69	60 - 600	227,2 - 2271,2	28,5	7,5
B134-540	4" × 4"	10	0,69	100 - 1,200	378,5 - 4542,5	14,5	3,8
B136-560	6" × 6"	10	0,69	200 - 2,50	757- 9463,5	3,5	0,9
B138-580	8" × 8"	10	0,69	350 - 3,500	1324,9 - 13249	1,5	0,4

<sup>1</sup> Includes standard magnetic pickup, p/n B111109, -101 to +165 °C (-150 to +330 °F), suitable for all mounting styles.

<sup>2</sup> All K-factors are approximate.

NOTE: Accuracy of these meters is ±4% of rate - for cement slurries and other applications with similar levels of particulate.

Table 19



# Blancett® QuikSert® turbine flow meters – Gas



## Suitable for:

- Flare gas
- Natural gas
- Methane
- Biogas
- Compressed gas
- Nitrogen

## Blancett® QuikSert® Gas

The Gas QuikSert® turbine flow meter provides long service life by offering a durable construction design composed of stainless steel and tungsten carbide shaft and bearings. The unique wafer style design allows for quick installation and easily fits between two ANSI flanges. Light weight, balanced rotor provides

an instantaneous response to changes in flow. Gas QuikSert® is compatible with all Blancett® flow monitors, K-factor scaler and intelligent converters.

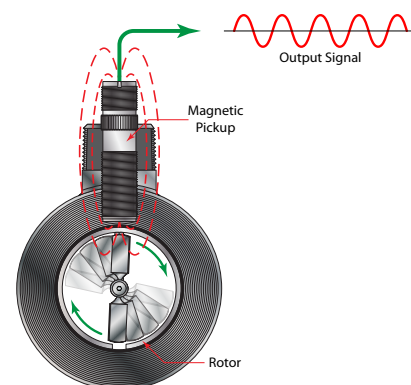

Illustration of electric signal generated by movement

## Specifications

Materials of construction	Body and cartridge	316/316 L stainless steel
	Rotor	410 stainless steel
	Bearings	Tungsten carbide
	Shaft	Tungsten carbide
Accuracy	± 1% of reading when integrated with a properly configured Blancett® flow monitor or signal conditioner	
Repeatability	± 0.5% of reading	
Linearity	± 2% of reading over the specified measuring range	
Calibration	Air (NIST traceable calibration)	
Operating temperature	-40 °C up to +165 °C (-40 °F up to +330 °F)	
End connections	Wafer-style ASME/ANSI B16.5-1996	
Intrinsically safe	Class I Division 1 Groups C, D [Entity Parameters $V_{max} = 10V$ , $I_{max} = 3 mA$ , $C_i = 0 \mu F$ and $L_i = 1.65 H$ with Blancett® B111113 magnetic pickup installed] for US and Canada. Complies with UL 913 and CSA 22.2 No. 157-92	
Approvals	Class I Division 1 Groups C, D. complies with UL1203 and CSA C22.2 No. 30-M1986	

\*Example 5 point calibration protocol for gas flow meters see appendix on page 58

## Blancett® QuikSert® Gas – without pickup

Part number <sup>1</sup>	Bore x line size	Flow rate <sup>1</sup>		K-factor <sup>2</sup>	
		ACFM	m <sup>3</sup> /h	pulses/ft <sup>3</sup>	pulses/m <sup>3</sup>
B142-20L	2" x 2"	7 - 70	12 - 118	365	12900
B142-20M		14 - 210	23,3 - 350	190	6710
B142-20H		35 - 350	58,3 - 583	85	3000
<b>Approvals:</b>	Explosion proof: Class I Division 1 Groups C, D, complies with UL1203 and CSA C22.2 No. 30-M1986 Intrinsically safe: Class I Division 1 Groups C, D [Entity Parameters Vmax = 10V, Imax = 3 mA, Ci = 0 µF and Li = 1.65 H with Blancett® B111113 magnetic pickup installed] for US and Canada. Complies with UL 913 and CSA 22.2 No. 157-92				

<sup>1</sup> Air at 0 bar (0 psi) and 15.6 °C (60 °F)

<sup>2</sup> All K-factors are approximate and determined with magnetic pickup B111113

Table 20

## Blancett® QuikSert® Gas pickup

Part number	Description
B111113	Gas QuikSert® magnetic pickup -101 °C up to +149 °C (-150 °F up to +300 °F)

Table 21

## Configuration examples

Monitor				
Mounting	Turbine (no pickup) <sup>1</sup>	Magnetic pickup <sup>2</sup>	Monitor <sup>3</sup>	Cable <sup>4</sup>
Meter mounted display	B142-20L	B111113	B30AM-CS	-
Remote mounted display (with cable)	B142-20L	B111113	B30AR-CS	B220-220 or B220-221

<sup>1</sup> Turbine example: see "Table 20" on page 31

<sup>2</sup> Pickup: see "Table 21" on page 31

<sup>3</sup> Monitors: see "Table 45" on page 49

<sup>4</sup> Cables: see "Table 52" on page 55

Monitor for hazardous location – Explosion proof			
Turbine (no pickup) <sup>1</sup>	Magnetic pickup <sup>2</sup>	Explosion proof meter mount kit	Explosion proof monitor <sup>3</sup>
B142-20L	B111113	B280-737	B30XR-CS

<sup>1</sup> Turbine example: see "Table 20" on page 31

<sup>2</sup> Pickup: see "Table 21" on page 31

<sup>3</sup> Monitor: see "Table 45" on page 49; Approvals see page 45

K-factor scaler			
Turbine (no pickup) <sup>1</sup>	Magnetic pickup <sup>2</sup>	K-factor scaler <sup>3</sup>	Programming software
B142-20L	B111113	B220-885	B220-900

<sup>1</sup> Turbine example: see "Table 20" on page 31

<sup>2</sup> Pickup: see "Table 21" on page 31

<sup>3</sup> K-factor scaler: see "Table 48" on page 52

Intelligent converter				
	Turbine <sup>1</sup>	Magnetic pickup <sup>2</sup>	Intelligent converter <sup>3</sup>	Programming kit
F to I intelligent converter	B142-20L	B111113	B220-873	B220-954
F to V intelligent converter	B142-20L	B111113	B220-874	B220-954

<sup>1</sup> Turbine example: see "Table 20" on page 31

<sup>2</sup> Pickup: see "Table 21" on page 31

<sup>3</sup> F to I and F to V converter: see "Table 49" on page 54

# FloClean 3-A sanitary turbine meters



- 3A sanitary standard
- Sanitary end connection
- Materials comply to FDA requirements

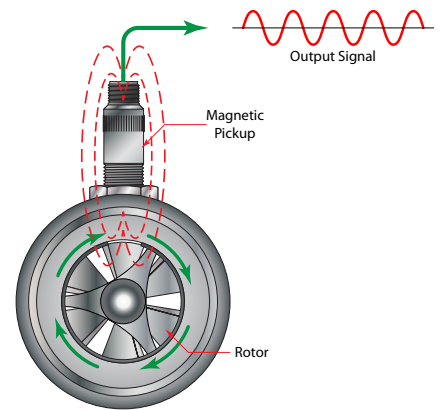

Illustration of electric signal generated by rotor movement

## FloClean with 3-A sanitary standard approval

The FloClean 3-A sanitary turbine flow meter meets 3-A sanitary standards. The meter is perfectly adapted for use in the food, beverage and pharmaceutical industries.

Combined with a Blancett® monitor, the meter provides actual flow rate and total flow rate.

## Specifications

Materials of construction	Body and internal wetted parts	316L stainless steel
	Turbine	Nickel plated CD4MCU stainless steel
	Bearings	Standard - nickel bindery tungsten carbide
	Shaft	Nickel bindery tungsten carbide
Accuracy	± 1% of reading	
Repeatability	± 0.1%	
Calibration	Water (NIST traceable calibration)	
pressure rating	69 bar / 1.000 psi (rating based on Tri-clamp®)	
Operating temperature	-101 °C up to + 149 °C (-150 up to + 300 °F)	
End connections	Sanitary clamp ends	
Sanitary rating	Clean-out-of-place (COP); sterilize-out-of-place (SOP)	
Approval	3-A sanitary standard	
Magnetic pickup	Several options available	

## FloClean B16D 3-A sanitary turbine flow meters (no hub)



Part number	Clamp size x bore size	Maximum pressure <sup>1</sup>	Flow rate		K-factor <sup>2</sup>	
			gal/min	l/min	pulses/gal	pulses/liter
B16D-003A-	¾" × 3/8"	69 bar (1000 psi)	0,6 - 3	2,3- 11,4	20000	5277
B16D-005A-	¾" × ½"		0,75 - 7,5	3 - 30	13000	3430
B16D-007A-	¾" × ¾"		2 - 15	7,5 - 57	2750	726
B16D-105A-	1½" × ½"		0,75 - 7,5	3 - 30	13000	3430
B16D-107A-	1½" × ¾"		2 - 15	7,5 - 57	2750	726
B16D-108A-	1½" × 7/8"		3 - 30	11 - 110	2686	709
B16D-110A-	1½" × 1"		5 - 50	19 - 190	870	230
B16D-115A-	1½" × 1½"		15 - 180	57 - 680	330	87
B16D-220A-	2½" × 2"		40 - 400	150 - 1500	52	14

<sup>1</sup> Rating based on Tri-clamp sanitary connection

<sup>2</sup> All K-factors are approximate

Table 22

Select pickup options from table below

### FloClean B16D 3-A sanitary turbine flow meters (no hub) - pickup options

Pickup selection <sup>1</sup>	Part number	Magnetic pickup	Description
0BA	B161109	NEMA 6	NEMA 6 magnetic pickup -101 °C to +165 °C (-150 °F to +330 °F)
1BA	B161210	NEMA 6 pre-amp	NEMA 6 magnetic pickup with preamplifier -29 °C to +71 °C (-20 °F to +160 °F)
2BA	B111109	Standard pickup	Standard magnetic pickup -101 °C to +165 °C (-150 °F to +330 °F)
3BA	B220210	Magnetic pickup pre-amp	Magnetic pickup with preamplifier -29 °C to +71 °C (-20 °F to +160 °F)
4BA	B220-950	F to I converter	F to I intelligent converter, 4-20 mA output in canister (includes magnetic pickup)
6BA	B220111	High temp pickup	High temp magnetic pickup -101 °C to +232 °C (-150 °F to +450 °F)
7BA	B161212	NEMA 6 pre-amp	NEMA 6 magnetic pickup with preamplifier (less Zener)
8BA	B220-951	F to V converter	F to V intelligent converter, 0-5 VDC output in canister (includes magnetic pickup)
9BA	-	No pickup	-

<sup>1</sup> Including standard 5 point calibration

Table 23

#### Ordering example:

B16D-007A-0BA

¾" × ¾" FloClean B16D 3-A sanitary turbine flow meter (no hub) with NEMA 6 magnetic pickup B161109

### Configuration examples

Monitor			
Mounting	Turbine with magnetic pickup <sup>1</sup>	Monitor <sup>2</sup>	Cable <sup>3</sup>
Remote mounted display (with cable)	B16D-003A-2BA	B30AR-CS	B220-220 or B220-221

<sup>1</sup> Turbine example: see "Table 22" on page 33

<sup>2</sup> Monitors: see "Table 45" on page 49

<sup>3</sup> Cables: see "Table 52" on page 55

Intelligent converter				
	Turbine <sup>1</sup>	Intelligent converter <sup>2</sup>	Programming kit	Cable <sup>3</sup>
F to I intelligent converter	B16D-003A-4BA	B220-950 included	B220-953	B220952-6
F to V intelligent converter	B16D-003A-8BA	B220-951 included	B220-953	B220952-6

<sup>1</sup> Turbine example: see "Table 22" on page 33

<sup>2</sup> Intelligent converter: see "Table 49" on page 54

<sup>3</sup> Cables: see "Table 52" on page 55

## FloClean B16D 3-A sanitary turbine flow meters (with hub)

Part number	Clamp size X bore size	Hub size	Maximum pressure <sup>1</sup>	Flow rate		K-factor <sup>2</sup>	
				gal/min	l/min	pulses/gal	pulses/liter
B16D-003A-	¾" × 3/8"	½" NPT	69 bar (1.000 psi)	0,6 - 3	2,3 - 11,4	20000	5.277
B16D-005A-	¾" × ½"			0,75 - 7,5	3 - 30	13000	3.430
B16D-007A-	¾" × ¾"			2 - 15	7,5 - 57	2750	726
B16D-105A-	1½" × ½"	1" NPT		0,75 - 7,5	3 - 30	13000	3.430
B16D-107A-	1½" × ¾"			2 - 15	7,5 - 57	2750	726
B16D-108A-	1½" × 7/8"			3 - 30	11 - 110	2686	709
B16D-110A-	1½" × 1"			5 - 50	19 - 190	870	230
B16D-115A-	1½" × 1½"			15 - 180	57 - 680	330	87
B16D-220A-	2½" × 2"			40 - 400	150 - 1500	52	14

<sup>1</sup> Rating based on Tri-clamp® sanitary connection.

<sup>2</sup> All K-factors are approximate.

Table 24

Select pickup options from table below

### FloClean B16D 3-A sanitary turbine flow meters (with hub) - pickup options

Pickup selection <sup>1</sup>	Part number	Magnetic pickup	Description
0AA	B161109	NEMA 6	NEMA 6 magnetic pickup -101 °C to +165 °C (-150 °F to +330 °F)
1AA	B161210	NEMA 6 pre-amp	NEMA 6 magnetic pickup with preamplifier -29 °C to +71 °C (-20 °F to +160 °F)
2AA	B111109	Standard pickup	Standard magnetic pickup -101 °C to +165 °C (-150 °F to +330 °F)
3AA	B220210	Magnetic pickup pre-amp	Magnetic pickup with preamplifier -29 °C to +71 °C (-20 °F to +160 °F)
4AA	B220-950	F to I converter	F to I intelligent converter, 4-20 mA output in canister (includes magnetic pickup)
6AA	B220111	High temp pickup	High temp magnetic pickup -101 °C to +232 °C (-150 °F to +450 °F)
7AA	B161212	NEMA 6 pre-amp	NEMA 6 magnetic pickup with preamplifier (less Zener)
8AA	B220-951	F to V converter	F to V intelligent converter, 0-5 VDC output in canister (includes magnetic pickup)
-	B111126	ATEX approved	ATEX  II 1G; EEx ia IIC T5, -50 - 120 °C (-58 - 248 °F)
9AA	-	No pickup	-

<sup>1</sup> Including standard 5 point calibration

Table 25

#### Ordering examples:

##### B16D-107A-2AA

1½" × ¾" FloClean B16D 3-A sanitary turbine flow meter (with hub) with standard magnetic pickup B111109

##### B16D-107A-9AA + B111126

1½" × ¾" FloClean B16D 3-A sanitary turbine flow meter (with hub) with ATEX approved magnetic pickup B111126

## Configuration examples

Monitor				
Mounting	Hub size	Turbine with magnetic pickup <sup>1</sup>	Bushing reducer <sup>2</sup>	Monitor <sup>3</sup>
Meter mounted display	½" NPT	B16D-005A-2AA	B220056 or B220057	B30AM-CS
	1" NPT	B16D-110A-2AA	not required	B30AM-CS

<sup>1</sup> Turbine example: see "Table 24" and "Table 25" on page 34

<sup>2</sup> Bushing reducer: see "Table 58" on page 56

<sup>3</sup> Monitors: see "Table 45" on page 49

### F to I intelligent converter

Hub size	Turbine <sup>1</sup>	Bushing reducer <sup>2</sup>	F to I intelligent converter <sup>3</sup>	Programming kit	Cable <sup>4</sup>
½" NPT	B16D-003A-2AA (with magnetic pickup)	B220056 or B220057	B220-873	B220-954	-
½" NPT	B16D-003A-4AA (with F to I converter and pickup)	not required	B220-950 already included	B220-953	B220952-6
1" NPT	B16D-108A-2AA (with magnetic pickup)	not required	B220-873	B220-954	-
1" NPT	B16D-108A-4AA (with F to I converter and pickup)	not required	B220-950 already included	B220-953	B220952-6

<sup>1</sup> Turbine: see "Table 24" and "Table 25" on page 34

<sup>2</sup> Bushing reducer: see "Table 58" on page 56

<sup>3</sup> F to I converter and Programming kit: see "Table 49" on page 54

<sup>4</sup> Cables: see "Table 52" on page 55

### F to V intelligent converter

Hub size	Turbine <sup>1</sup>	Bushing reducer <sup>2</sup>	F to V intelligent converter <sup>3</sup>	Programming kit	Cable <sup>4</sup>
½" NPT	B16D-003A-2AA (with magnetic pickup)	B220056 or B220057	B220-874	B220-954	-
½" NPT	B16D-003A-8AA (with F to V converter and pickup)	not required	B220-951 already included	B220-953	B220952-6
1" NPT	B16D-108A-2AA (with magnetic pickup)	not required	B220-874	B220-954	-
1" NPT	B16D-108A-8AA (with F to V converter and pickup)	not required	B220-951 already included	B220-953	B220952-6

<sup>1</sup> Turbine example: see "Table 24" and "Table 25" on page 34

<sup>2</sup> Bushing reducer: see "Table 58" on page 56

<sup>3</sup> F to V converter and programming kit: see "Table 49" on page 54

<sup>4</sup> Cables: see "Table 52" on page 55

### Monitor for hazardous locations

	Hub size	Turbine <sup>1</sup> (no pickup)	Magnetic pickup <sup>2</sup>	Explosion proof meter mount kit	Explosion proof monitor <sup>3</sup>	Cable <sup>3</sup>
For hazardous location - explosion proof	½" NPT	B16D-005A	2AA (B111109)	B280-742	B30XR-CS	-
	1" NPT	B16D-107A	2AA (B111109)	B280-737	B30XR-CS	-
For hazardous location - Intrinsically safe	½" NPT	B16D-005A-9AA	(B111126)	-	B30XR-CS	B220-220 or B220-221
	1" NPT	B16D-107A-9AA	(B111126)	-	B30XR-CS	B220-220 or B220-221
ATEX	½" NPT	B16D-005A-9AA	(B111126)	-	E110	-

<sup>1</sup> Turbine example: see "Table 24" on page 34

<sup>2</sup> Magnetic pickup: see "Table 25" on page 34

<sup>3</sup> Monitors: see "Table 45" on page 49; Approvals on page 48 and "Table 47" on page 50; Approvals on page 39

<sup>4</sup> Cables: see "Table 52" on page 55

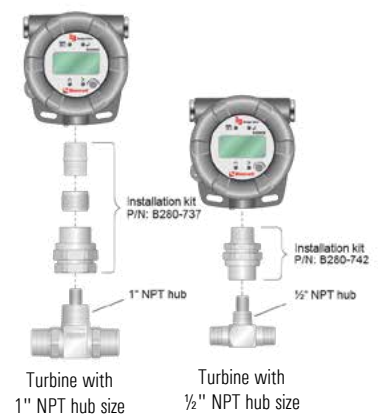

# Blancett® model 1750 – Positive displacement gear flow meters



- No need for additional straight run piping
- Designed for fluids with a wide range of viscosities, as well as low flow rates
- Available in high strength aluminum or stainless steel housing
- Applications: paint, grease, hydraulics, solvents, fuels

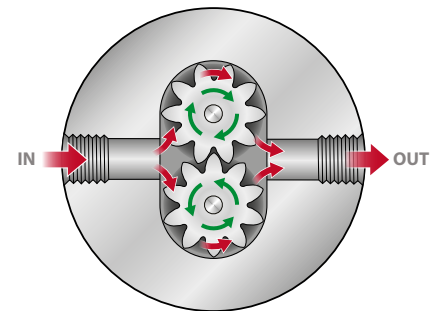

Operating principle

## Positive displacement gear flow meters

Because turbine meters are not suitable for every liquid application, Badger Meter also offers other metering technologies. Two types of adjacent liquid metering applications often associated with common turbine-metering applications are measurement of higher-viscosity liquids and

liquids containing small particulates. Positive displacement and impeller meter technologies are appropriate for these applications. The B1750 is a bi-directional flow meter when using appropriate electronics.

## Specifications

Materials of construction	Housing	6061-T6 aluminum or 303 stainless steel
	Gears	Stainless steel
	Bearings	Stainless steel
	O-Ring	Teflon® (standard), Viton® (optional)
Accuracy	±0.5% over the published flow range with fluids >100 cP; over a 10:1 turndown (from maximum flow) with fluids <30 cP	
Repeatability	±0.1%	
Calibration	Oil, DTE-27 at 21 °C (70 °F)	
Operating temperature	-29 up to 85 °C (-20 up to +185 °F) aluminum housing -29 up to 205 °C (-20 up to +400 °F) stainless steel housing	
Connections	Female NPT: ¼", ½", ¾" or 1 ¼" (depending on meter size)	

## Model 1750 - Positive displacement gear flow meters – Aluminum housing, 85 °C (185 °F) maximum fluid temperature without magnetic pickup / sensor

Part number <sup>1</sup>	Seal Material	End connections)	Maximum pressure	Flow rate <sup>2</sup>		K-factor <sup>3</sup>		
				gal/min	l/min	Pulses/gal	Pulses/liter	
B175-A12	Teflon® (standard)	¼" Female NPT	345 bar (5000 psi)	0,003 - 0,8	0,011 - 3	53000	13984	
B175-A20				0,01 - 2	0,04 - 7,6	15900	4195	
B175-A30				½" Female NPT	0,03 - 7	0,11 - 26,5	6600	1741
B175-A60					¾" Female NPT	0,05 - 20	0,19 - 75,7	1800
B175-A80 <sup>4</sup>				1¼" Female NPT	0,5 - 60	1,9 - 227	1600 <sup>5</sup>	422
B175-A90 <sup>4</sup>				1¼" Female NPT	1 - 120	3,8 - 454	800 <sup>5</sup>	211
B175-A12-V	Viton®	¼" Female NPT		0,003 - 0,8	0,011 - 3	53000	13984	
B175-A20-V				0,01 - 2	0,04 - 7,6	15900	4195	
B175-A30-V				½" Female NPT	0,03 - 7	0,11 - 26,5	6600	1741
B175-A60-V					¾" Female NPT	0,05 - 20	0,19 - 75,7	1800
B175-A80-V <sup>4</sup>				1¼" Female NPT	0,5 - 60	1,9 - 227	1600 <sup>5</sup>	422
B175-A90-V <sup>4</sup>				1¼" Female NPT	1 - 120	3,8 - 454	800 <sup>5</sup>	211

Table 26

<sup>1</sup> Does not include pickup. Available pickup options in "Table 28" on page 38.

<sup>2</sup> Working flow range - accuracy based on a 30 cSt fluid measured over a 10:1 turndown

<sup>3</sup> All K-factors are approximate.

<sup>4</sup> 90 flange fittings required for installation, see fittings options in "Table 29" on page 38.

<sup>5</sup> Configured for quad4 sensor output.

## Model 1750 - Positive displacement gear flow meters – 303 stainless steel housing, 205 °C (400 °F) maximum fluid temperature without magnetic pickup / sensor

Part number <sup>1</sup>	Seal material	End connections	Maximum pressure	Flow rate <sup>2</sup>		K-factor <sup>3</sup>		
				gal/min	l/min	Pulses/gal	Pulses/liter	
B175-S12	Teflon® (standard)	¼" Female NPT	345 bar (5000 psi)	0,003 - 0,8	0,011 - 3	53000	13984	
B175-S20				0,01 - 2	0,04 - 7,6	15900	4195	
B175-S30				½" Female NPT	0,03 - 7	0,11 - 26,5	6600	1741
B175-S60					¾" Female NPT	0,05 - 20	0,19 - 75,7	1800
B175-S80 <sup>4</sup>				1¼" Female NPT	0,5 - 60	1,9 - 227	1600 <sup>5</sup>	422
B175-S90 <sup>4</sup>				1¼" Female NPT	1 - 120	3,8 - 454	800 <sup>5</sup>	211
B175-S12-V	Viton®	¼" Female NPT		0,003 - 0,8	0,011 - 3	53000	13984	
B175-S20-V				0,01 - 2	0,04 - 7,6	15900	4195	
B175-S30-V				½" Female NPT	0,03 - 7	0,11 - 26,5	6600	1741
B175-S60-V					¾" Female NPT	0,05 - 20	0,19 - 75,7	1800
B175-S80-V <sup>4</sup>				1¼" Female NPT	0,5 - 60	1,9 - 227	1600 <sup>5</sup>	422
B175-S90-V <sup>4</sup>				1¼" Female NPT	1 - 120	3,8 - 454	800 <sup>5</sup>	211

Table 27

<sup>1</sup> Does not include pickup - to order, see pickup options in "Table 28" on page 38.

<sup>2</sup> Working flow range - accuracy based on a 30 cSt fluid measured over a 10:1 turndown.

<sup>3</sup> All K-factors are approximate.

<sup>4</sup> 90 flange fittings required for installation, see fittings options in "Table 29" on page 38.

<sup>5</sup> Configured for quad4 sensor output.



## Blancett® model 1750 - positive displacement gear flow meters - pickup / sensor options

Part number	Description	For use with
B170109	Magnetic pickup	B175-A60 & B175-S60
B170110	Pre-amp pickup	B175-A12 thru -A30 & B175-S12 thru -S30
B170111	Magnetic pickup	B175-A20 thru -A30 & B175-S20 thru -S30
B170112	Pre-amp pickup	B175-A20 thru -A30 & B175-S20 thru -S30
B170180	Quad 4 sensor	B175-A80 thru -A90 & B175-S80 thru -S90
B170210*	Magnetic pickup with preamplifier	B175-A60 & B175-S60
B170310	Cable for quad 4 sensor; 10 ft.	B175-A80 thru -A90 & B175-S80 thru -S90
B170311	Connector for quad 4 cable	B175-A80 thru -A90 & B175-S80 thru -S90
B175420 <sup>1</sup>	4-20 mA sensor in explosion proof housing	B175-A12 thru -A60 & B175-S12 thru -S60

\* Cable for quad 4 sensor is B170310; Connector for quad 4 sensor is B170311

<sup>1</sup> Cable B220-219 can be used with B175420.

Table 28

## Blancett® model 1750 - positive displacement gear flow meters - fitting options

Part number	Description	For use with
B175CSF	Carbon steel 90 flange to 1¼" NPT	B175-A80 & B175-A90
B175SSF	304 SS 90 flange to 1¼" NPT	B175-S80 & B175-S90

Table 29

## Blancett® model 1750 - positive displacement gear flow meters - display options

Part number	Description	For use with
BRT30SD	Flow transmitter with local display	B175-A80 thru -A90 & B175-S80 thru -S90
B29AR-CS	Display B2900	for gear flow meters see "Table 26" and "Table 27" on page 37
B30AR-CS	Display B3000	for gear flow meters see "Table 26" and "Table 27" on page 37

Table 30

## Configuration examples

Monitor					
Positive displacement (no pickup) <sup>1</sup>	Quad sensor <sup>2</sup>	Connector for quad sensor <sup>3</sup>	Cable for quad sensor <sup>4</sup>	Monitor <sup>5</sup>	Flange fittings <sup>6</sup>
B175-S90-V	B170180	B170311	B170310	B29AR-CS	2x B17555F

<sup>1</sup> Positive displacement: see "Table 27" on page 37

<sup>2,3,4</sup> Quad sensor, connector and cable: see "Table 28" on page 38

<sup>5</sup> Monitor: see "Table 44" on page 46

<sup>6</sup> Fittings: see "Table 29" on page 38

Monitor			
Positive displacement (no pickup) <sup>1</sup>	Magnetic pickup <sup>2</sup>	Cable <sup>3</sup>	Monitor <sup>4</sup>
B175-S60-V	B170109	B220-221	B29AR-CS

<sup>1</sup> Positive displacement: see "Table 27" on page 37

<sup>2</sup> Pickup: see "Table 28" on page 38

<sup>3</sup> Cables: see "Table 52" on page 55



<sup>4</sup> Monitor: see "Table 44" on page 46

# Flow monitors

## B2800 / B2900 / B3000 / E110 flow monitors for the Blancett® series

The flow monitors complement the Blancett® turbine meters.  
They offer various mounting possibilities for flexible meter reading on site.



Type	B2800	B2900	B3000	E110
<b>Power supply</b>	1.5 VDC alkaline battery or 4 – 20 mA / 30 VDC loop-powered	3.6 V lithium battery or 4 - 20 mA loop-powered	3.6 V lithium battery 4 – 20 mA loop-powered Solar-powered	9 – 27V DC + sensor supply 3.6 V lithium battery
<b>Mounting possibilities</b>	Meter mounted <sup>1</sup> Remote mount Swivel mount Panel mount Explosion proof, remote mount <sup>2</sup>	Meter mounted <sup>1</sup> Remote mount Swivel mount	Meter mounted <sup>1</sup> Remote mount Swivel mount Explosion proof, remote mount <sup>2</sup>	Meter mounted
<b>Outputs</b>	4 – 20 mA Pulse output	4 – 20 mA Pulse output ModBus® RTU Open collector	4 – 20 mA Pulse output ModBus® RTU over RS 485 (B30 Advanced)	4 – 20 mA (NPN) Passive transistor output
<b>Approvals</b>	CSA intrinsically safe (for meter mounted, remote and swivel mounted): Class I, Division 1, Groups C & D Class II, Division 1, Groups E, F, G  CE (for meter mounted, remote and swivel mounted): IEC 61326-1  CSA hazardous locations (explosion proof): Class I, Division 1, Groups B, C & D Class II, Groups E, F & G / Class III, Type 4, T6@70 C	Class I, Division 1, Groups C, D Class II, Division 1, Groups E, F, G Class III for USA and Canada. Corresponds to UL 913 and CSA C22.2 n° 153 EMC: IEC 61326-1; 2004/108/EC	B30 Advanced/Base/Solar: Class I, Division 1, Groups C, D Class II, Division 1, Groups E, F, G Class III for USA and Canada Corresponds to UL 913 and CSA C22.2 n° 157-92.  B30 explosion proof Advanced/Base: Class I, Division 1, Groups B, C, D Class II, Division 1, Groups E, F, G Class III for USA and Canada complies with UL 1203 and CSA C22.2 n° 30-M1986.  B30 explosion proof Advanced/Base: ATEX II 2 G Ex d IIC T4 Gb and ATEX II D Ex tb IIC T125 °C Db	ATEX Gas:  II 2G Ex d IIC T6 Gb Dust:  II 2D tb IIIC T85 °C Db  IECEx Gas: Ex d IIC T6 Gb Dust: Ex tb IIIC T85°C Db  FM & CSA <sub>C-US</sub> Class I, Div. 1, Groups A, B, C, D. Class II/III, Div. 1, Groups E, F, G Class I, Zone 1, AEx d IIC T6 Gb, Zone 21, AEx tb IIIC T85°C Db.
<b>Enclosure rating</b>	NEMA 4X (IP 66)	NEMA 4X (IP 66)	NEMA 4X (IP 66)	NEMA 4X, NEMA 7, NEMA 9 (IP 66, IP67)

<sup>1</sup> Bushing reducer required for ½" hub turbine meters to mount accessories on meter (see "Table 58" on page 56)

<sup>2</sup> Explosion proof kit for explosion proof system required (see "Table 59" on page 56)

# Blancett® flow monitor B2800



Blancett® B2800 flow monitor meter mount

Model B2800 is a technologically advanced flow monitor designed to be comprehensive, user-friendly, flexible and cost efficient. The digital signal processing display comes precalibrated by the factory when purchased with a Blancett® turbine flow meter; otherwise, it can easily be

configured in the field. The B2800 can be utilized with nearly any flow sensor that outputs a low-amplitude AC signal.

- Displays rate and/or total on a large 8-digit by 3/4" display
- User-friendly front panel programming
- Six mounting options available: meter, remote, swivel, handheld, panel or explosion proof
- Simplified model displays in five selectable units of measure
- CSA Class I, Div 1 approval

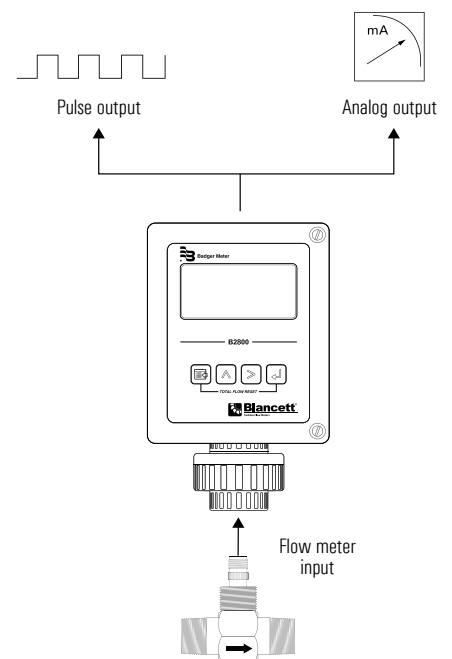

## Specifications

Power	Battery	1.5V DC alkaline battery
	Loop-powered	4-20 mA, two-wire current loop
Pulse Output	One pulse for each increment of the least significant digit of totalizer	
	Pulse type	Opto-isolated open collector transistor
	Max. voltage	30V DC
	Pulse width	(ON State) 20 ms/max pulse rate 20 Hz
Inputs	Current	(ON State) 0.9V drop @ 5.0 mA or 0.7V drop @ 0.1 mA
	Magnetic pickup	
	Frequency range	1-3500 Hz
	Trigger sensitivity	30 mV p-p
Accuracy	Over-voltage protected	30V DC
		+/- 0.1%
Operating Temperature	-30 up to +70 °C (-22 up to +158 °F)	
Analog Output	Loop-powered	4-20 mA
Enclosure Rating	Meter, remote and swivel mount	NEMA/UL/CSA Type 4X (IP-66)
	Explosion-proof	NEMA 4X (IP-66)
Approval	Meter, remote and swivel mount	CSA Intrinsically Safe Class I, Division 1, Groups C & D, Class II, Division 1, Groups E, F & G; CE IEC 61326-1
	Explosion-proof	CSA Hazardous Location Class I, Division 1, Groups B, C & D, Class II, Groups E, F & G, Class III, Type 4X, T6 @ 70 C

## Part number construction

### Blancett® B2800 Display

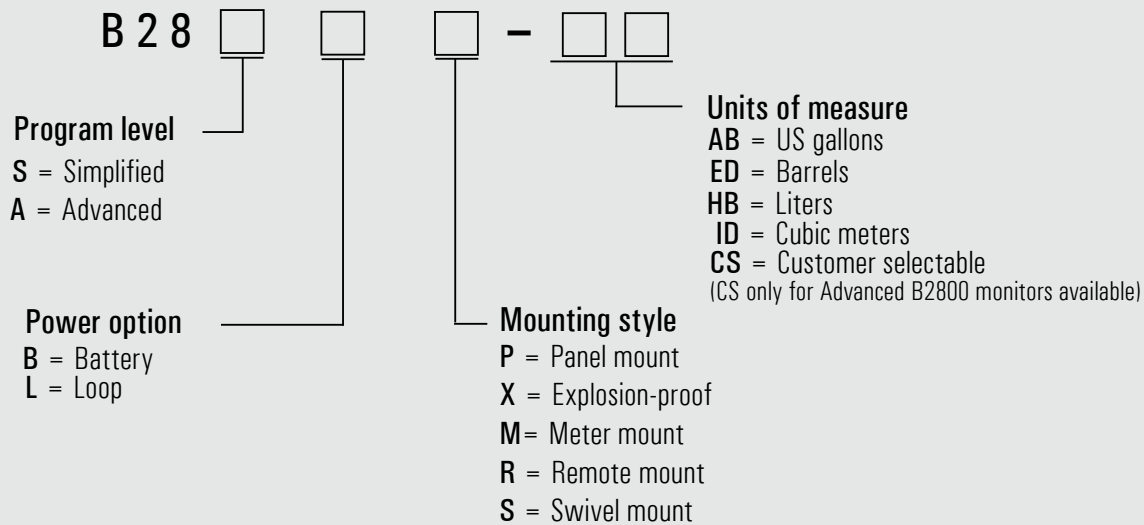

## B2800 flow monitors, simplified – battery powered

Part number	Units of measure	Mounting style
B28SBM-AB	Gallons	Meter mount
B28SBR-AB		Remote mount (less cable)
B28SBS-AB		Swivel mount
B28SBP-AB		Panel mount
B28SBX-AB		Explosion proof, remote mount
B28SBM-HB	Liters	Meter mount
B28SBR-HB		Remote mount (less cable)
B28SBS-HB		Swivel mount
B28SBP-HB		Panel mount
B28SBX-HB		Explosion proof, remote mount
B28SBM-ED	Barrels	Meter mount
B28SBR-ED		Remote mount (less cable)
B28SBS-ED		Swivel mount
B28SBP-ED		Panel mount
B28SBX-ED		Explosion proof, remote mount
B28SBM-ID	Cubic meters	Meter mount
B28SBR-ID		Remote mount (less cable)
B28SBS-ID		Swivel mount
B28SBP-ID		Panel mount
B28SBX-ID		Explosion proof, remote mount

Table 31

### B2800 flow monitor, explosion proof, simplified – battery powered

Part number	Units of measure	Mounting style
B28SBX-AB	Gallons	Explosion proof, remote mount
B28SBX-HB	Liters	
B28SBX-ED	Barrels	
B28SBX-ID	Cubic meters	

Table 32



Blancett® B2800 explosion proof with explosion proof kit and 1100 series turbine

### B2800 flow monitor, simplified – battery powered (vented) with supplemental vent for high humidity applications

Part number	Units of measure	Mounting style
B28SBM-V-AB	Gallons	Meter mount
B28SBR-V-AB		Remote mount (less cable)
B28SBS-V-AB		Swivel mount
B28SBM-V-HB	Liters	Meter mount
B28SBR-V-HB		Remote mount (less cable)
B28SBS-V-HB		Swivel mount
B28SBM-V-ED	Barrels	Meter mount
B28SBR-V-ED		Remote mount (less cable)
B28SBS-V-ED		Swivel mount
B28SBM-V-ID	Cubic meters	Meter mount
B28SBR-V-ID		Remote mount (less cable)
B28SBS-V-ID		Swivel mount

Table 33

### B2800 flow monitor, simplified – loop powered/4-20 mA (vented) with supplemental vent for high humidity applications

Part number	Units of measure	Mounting style
B28SLM-V-AB	Gallons	Meter mount
B28SLR-V-AB		Remote mount (less cable)
B28SLS-V-AB		Swivel mount
B28SLM-V-HB	Liters	Meter mount
B28SLR-V-HB		Remote mount (less cable)
B28SLS-V-HB		Swivel mount
B28SLM-V-ED	Barrels	Meter mount
B28SLR-V-ED		Remote mount (less cable)
B28SLS-V-ED		Swivel mount
B28SLM-V-ID	Cubic meters	Meter mount
B28SLR-V-ID		Remote mount (less cable)
B28SLS-V-ID		Swivel mount

Table 34

## B2800 flow monitor, explosion proof, simplified – loop powered/4–20mA

Part number	Units of measure	Mounting style
B28SLX-AB	Gallons	Explosion proof, remote mount
B28SLX-HB	Liters	
B28SLX-ED	Barrels	
B28SLX-ID	Cubic meters	

Table 35

## B2800 flow monitor, simplified – loop powered/4-20 mA

Part number	Units of measure	Mounting style
B28SLM-AB	Gallons	Meter mount
B28SLR-AB		Remote mount (less cable)
B28SLS-AB		Swivel mount
B28SLP-AB		Panel mount
B28SLX-AB		Explosion proof, remote mount
B28SLM-HB	Liters	Meter mount
B28SLR-HB		Remote mount (less cable)
B28SLS-HB		Swivel mount
B28SLP-HB		Panel mount
B28SLX-HB		Explosion proof, remote mount
B28SLM-ED	Barrels	Meter mount
B28SLR-ED		Remote mount (less cable)
B28SLS-ED		Swivel mount
B28SLP-ED		Panel mount
B28SLX-ED		Explosion proof, remote mount
B28SLM-ID	Cubic meters	Meter mount
B28SLR-ID		Remote mount (less cable)
B28SLS-ID		Swivel mount
B28SLP-ID		Panel mount
B28SLX-ID		Explosion proof, remote mount

Table 36

## B2800 flow monitor, advanced – battery powered

Part number	Units of measure	Mounting style
B28ABM-CS	Customer selectable	Meter mount
B28ABR-CS		Remote mount (less cable)
B28ABS-CS		Swivel mount
B28ABP-CS		Panel mount
B28ABX-CS		Explosion proof, remote mount only

Table 37

## B2800 flow monitor, explosion proof, advanced – battery powered

Part number	Units of measure	Mounting style
B28ABX-CS	Customer selectable	Explosion proof, remote mount

Table 38

### B2800 flow monitor, advanced – battery powered (vented) with supplemental vent for high humidity applications

Part number	Units of measure	Mounting style
B28ABM-V-CS	Customer selectable	Meter mount
B28ABR-V-CS		Remote mount (less cable)
B28ABS-V-CS		Swivel mount

Table 43

### B2800 flow monitor, advanced – loop powered/4-20 mA

Part number	Units of measure	Mounting style
B28ALM-CS	Customer selectable	Meter mount
B28ALR-CS		Remote mount (less cable)
B28ALS-CS		Swivel mount
B28ALP-CS		Panel mount
B28ALX-CS		Explosion proof, remote mount

Table 39

### B2800 flow monitor explosion proof, advanced – loop powered/4-20 mA

Part number	Units of measure	Mounting style
B28ALX-CS	Customer selectable	Explosion proof, remote mount

Table 40

### B2800 flow monitor, advanced – loop powered/4-20 mA (vented) with supplemental vent for high humidity applications

Part number	Units of measure	Mounting style
B28ALM-V-CS	Customer selectable	Meter mount
B28ALR-V-CS		Remote mount (less cable)
B28ALS-V-CS		Swivel mount

Table 41

### Explosion proof kit (hazardous location)

Part number	Description
B280-737	For 1" NPT Hub for remote mount display B30X or B2800XP
B280-742	For ½" NPT Hub for remote mount display B30X or B2800XP

Table 42

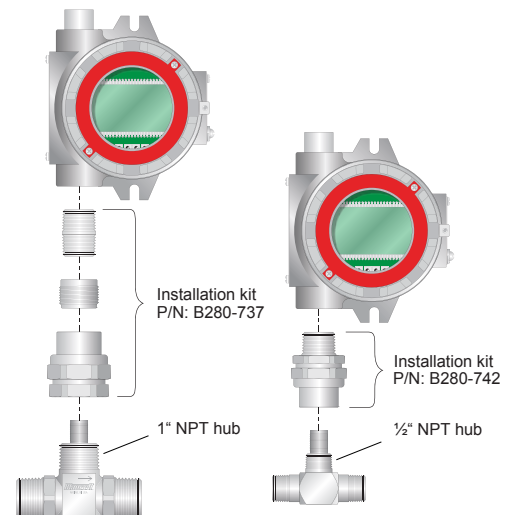

# Blancett® flow monitor B2900



Blancett® B2900  
flow monitor  
meter mount

The B2900 monitor uses the frequency information to calculate flow rate and total flow. Through the use of the programming buttons, you can select rate units, total units and unit time intervals among other functions. If required, the monitor can easily be re-configured in the field. Finally, you can choose between simultaneously showing rate and total, or alternating

between rate and grand total. The monitor provides advanced communication capabilities over an RS485 bus using Modbus RTU and control outputs. The B2900 can be utilized with nearly any flow sensor that outputs a low-amplitude AC signal or contact closure signal.

- Advanced connectivity options allow you to connect meters to your network for remote monitoring and process automation capabilities.
- Updated display and totalization options provide more flow information, including simultaneous display of rate and total as well as standard, batch and grand totals.

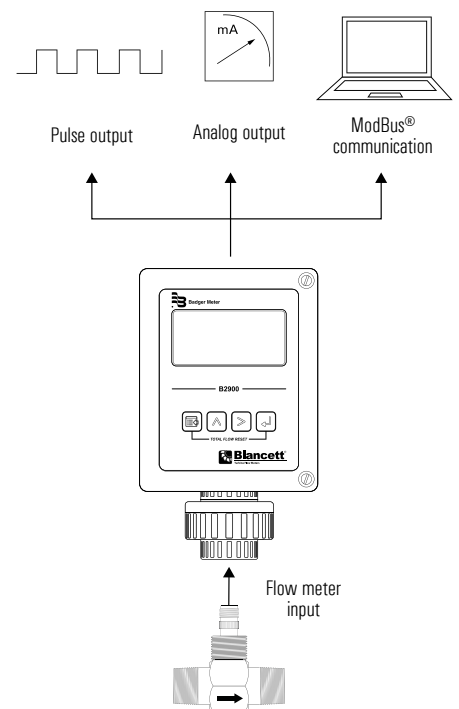

## Specifications

Power	Battery	3.6V DC lithium D Cell
	Loop	4–20 mA, two wire
Inputs	Magnetic pickup	Frequency range: 1–3500 Hz
		Frequency measurement accuracy: $\pm 0.1\%$
		Over voltage protection: 28V DC
	Amplified pulse	Direct connection to amplified signal (pre-amp output from sensor)
Outputs	Analog 4–20 mA	
	Totalizing pulse	
	Status alarms	
ModBus® digital communications	Modbus RTU over RS485	
Approvals	Safety: Intrinsically Safe (Class I Division 1, Groups C, D; Class II, Division 1 Groups E, F, G) EMC: IEC61326-1; 2004/108/EC	
Measurement accuracy	0.05%	
Temperature	-30 up to +70 °C (-22 up to +158 °F)	
Materials and enclosure ratings	Polycarbonate, stainless steel, polyurethane, thermoplastic elastomer, acrylic; NEMA 4X/IP 66 meter, remote and swivel mount; NEMA/UL/CSA Type 4X (IP-66)	



### Part number construction

<b>Blancett® B2900 Display</b>					
<b>Model</b>	Blancett® B2900 display	<b>B29</b>			
<b>Model</b>	Advanced	<b>A</b>			
<b>Mounting</b>	Meter		<b>M</b>		
	Remote		<b>R</b>		
	Swivel		<b>S</b>		
<b>Units of measure</b>	Customer selectable				<b>CS</b>

### B2900 flow monitor, loop powered/4-20 mA and battery powered

Part number	Model	Power Source	Mounting style
B29AM-CS	Advanced	Battery and loop	Meter mount
B29AR-CS			Remote mount (less cable)
B29AS-CS			Swivel mount

NOTE: "Advanced" models are loop-powered with 4/20mA and pulse outputs and include battery back-up power supply.  
 NOTE: "Advanced" units include 2 adjustable flow rate alarm and ModBus® RTU digital communications over RS485.

Table 44

# Blancett® flow monitor B3000



Blancett® B3000  
flow monitor  
swivel mount

This rugged flow monitor is ideal for harsh industrial applications. Stainless steel and tungsten carbide components ensure long life. These products are also well-suited for industrial applications with high temperature and high

pressure applications, for example in secondary oil recovery, semiconductor and chemical processing. Electronic options enable the meter to interface with most computers and PLCs.

- Advanced connectivity options allow you to connect meters to your network for remote monitoring and process automation capabilities.
- Updated display and totalization options provide more flow information, including simultaneous display of rate and total as well as standard, batch and grand totals.

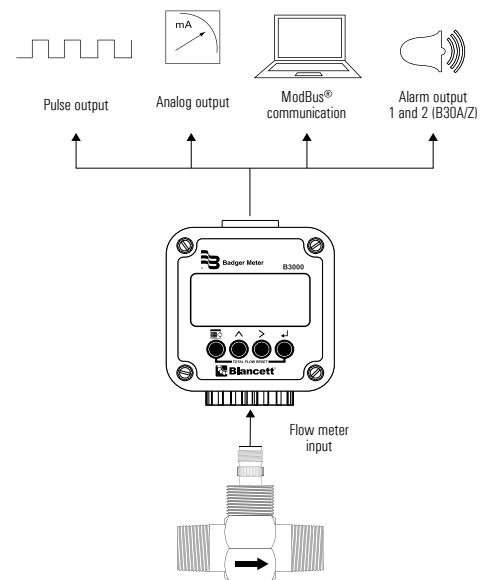

## Specifications

	Simultaneously shows rate and total; 5 x 7 dot matrix LCD, STN fluid		
Display	B30A/B/S	6 digit rate, 12,7 mm (0,5") numeric	
		7 digit total, 12,7 mm (0,5") numeric	
		Engineering unit labels 8,6 mm (0,34" )	
B30X/Z	6 digit rate, 9,4 mm (0,37") numeric		
	7 digit total, 13 mm (0,37" ) numeric		
	Engineering unit labels 6,1 mm (0,24")		
Annunciators	Alarm 1 (🔊), Alarm 2 (🔊), battery level (🔋), RS485 communications (COM)		
Power	B30A/B/X/Z	Auto switching between internal battery and external loop power; B30A/Z includes isolation between loop power and other I/O	
		Battery	3,6V DC lithium "D Cell" gives up to 6 years of service life
		Loop	4–20 mA, two wire, 25 mA limit, reverse polarity protected, 7V DC loop loss
B30S	Internal battery (3.6V DC Nicd) provides up to 30 days of power after 6–8 hours exposure of the integrated photovoltaic cell to direct sunlight.		
Inputs	Magnetic pickup	Frequency range	1–3500 Hz
		Frequency measurement accuracy	±0.1%
		Over voltage protection	28V DC
		Trigger sensitivity	30 mVp-p (high) or 60 mVp-p (low) - (selected by circuit board jumper)
Amplified pulse	Direct connection to amplified signal (pre-amp output from sensor)		

## Specifications

Outputs	Analog 4–20 mA	4–20 mA, two-wire current loop; 25 mA current limit				
	Totalizing pulse	One pulse for each Least Significant Digit (LSD) increment of the totalizer				
		Pulse type (selected by circuit board jumper)	Opto-isolated (Iso) open collector transistor; Non-isolated open drain FE			
		Maximum voltage	28V DC			
		Maximum current capacity	100 mA			
		Maximum output frequency	16 Hz			
	Pulse width	30 mSec fixed				
Status alarms	B30A/Z	Open collector transistor; adjustable flow rate with programmable dead band and phase.				
		Maximum voltage	28V DC			
		Maximum current	100 mA			
	Pullup resistor	External required (2.2 k ohm min., 10 k ohm max.)				
B30B/S/X	None					
ModBus® digital communications	B30A/Z	ModBus® RTU over RS485, 127 addressable units / 2-wire network, 9600 baud, long integer and single precision IEEE754 formats; retrieve: flow rate, job totalizer, grand totalizer, alarm status and battery level; write: reset job totalizer, reset grand totalizer.				
	B30B/S/X	None				
Data configuration and protection	B30A/B/X/Z	Two four-digit user selectable passwords; level one password enables job total reset only, level two password enables all configuration and totalizer reset functions				
Approvals	Safety	B30A/B/S	Class I Division 1, Groups C, D; Class II, Division 1 Groups E, F, G; Class III for US and Canada. Complies with UL 913 and CSA C22.2 No. 157-92			
		B30X/Z	Class I Division 1 Groups B, C, D; Class II, Division 1, Groups E, F, G; Class III for US and Canada. Complies with UL 1203 and CSA C22.2 No. 30-M1986 ATEX II 2 G Ex d IIC T4 Gb and ATEX II D Ex tb IIIC T135 °C Db Complies with Directive 94/9/EC.			
	Entity parameters	B30A/B	4-20 mA loop: Vmax = 28V DC	I <sub>max</sub> = 26 mA	C <sub>i</sub> = 0.5 μF	Li = 0 mH
		B30A/B/S	Pulse output: Vmax = 28V DC	I <sub>max</sub> = 100 mA	C <sub>i</sub> = 0 μF	Li = 0 mH
		B30A/B/S	Reset input: Vmax = 5V DC	I <sub>max</sub> = 5 mA	C <sub>i</sub> = 0 μF	Li = 0 mH
		B30A	RS485: Vmax = 10V DC	I <sub>max</sub> = 60 mA	C <sub>i</sub> = 0 μF	Li = 0 mH
B30A/B/S		Turbine input: Voc = 2.5V	I <sub>sc</sub> = 1.8 mA	Ca = 1.5 μF	La = 1.65 H	
EMC	2004/108/EC					
Materials and enclosure ratings	B30A/B/S	Polycarbonate, stainless steel, polyurethane, thermoplastic elastomer, acrylic; NEMA 4X/IP 66				
	B30X/Z	Copper free, epoxy-coated, aluminum, buna seal, NEMA 4X/IP66				
Engineering units	Liquid	Gallons, liters, oil barrels (42 gallon), liquid barrels (31.5 Gallon), cubic meters, million gallons, cubic feet, million liters, acre feet				
	Gas	Cubic feet, thousand cubic feet, million cubic feet, standard cubic feet, actual cubic feet, normal cubic meters, actual cubic meters, liters				
	Rate Time	Seconds, minutes, hours, days				
	Totalizer Exponents	0.00, 0.0, X1, x10, x100, x1000				
Measurement accuracy	0.05%					
Response time (damping)	1–100 seconds response to a step change input, user adjustable					
Environmental limits	-30 up to 70 °C (-22 up to 158 °F); 0–90% humidity, non-condensing					

### Part number construction

Blancett® B3000 display					
<b>Model</b>					
Blancett® B3000 Display	<b>B30</b>				
<b>Model</b>					
Base	<b>B</b>				
Advanced	<b>A</b>				
Solar	<b>S</b>				
Base – explosion proof* – Battery and loop powered	<b>X</b>				
Advanced – explosion proof* – Battery and loop powered	<b>Z</b>				
<b>Mounting</b>					
Meter				<b>M</b>	
Remote				<b>R</b>	
Swivel				<b>S</b>	
<b>Units of measure</b>					
Customer selectable					<b>CS</b>

\* For hazardous locations the monitor must be installed on an explosion proof rated meter.

### B3000 flow monitor, loop powered/4-20 mA and battery powered

Part number	Units of measure	Power source	Mounting style
B30AM-CS	Advanced	Battery and loop	Meter mount
B30AR-CS			Remote mount (less cable)
B30AS-CS			Swivel mount
B30BM-CS	Base	Battery and loop	Meter mount
B30BR-CS			Remote mount (less cable)
B30BS-CS			Swivel mount
B30SM-CS	Solar	Battery and solar	Meter mount
B30SR-CS			Remote mount (less cable)
B30SS-CS			Swivel mount
B30XR-CS	Base	Battery and loop	Explosion proof, remote mount (less cable)
B30ZR-CS	Advanced	Battery and loop	Explosion proof, remote mount (less cable)

Table 45



Blancett® B3000 explosion proof flow monitor, explosion proof kit and 1100 series flow meter

### Explosion proof kit (hazardous location)

Part number	Description
B280-737	For 1" NPT Hub for remote mount display B30X or B2800XP
B280-742	For ½" NPT Hub for remote mount display B30X or B2800XP

Table 46

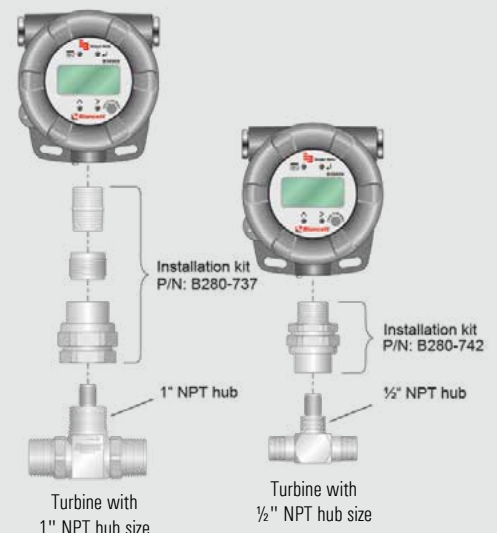

## E110 flow monitor, loop powered, 4-20 mA output, explosion proof, meter mount

The E110 monitor is a popular model in our range of explosion proof flow rate indicators. The monitor distinguishes itself by its quality and functionality driven European design and manufacturing.



E110 explosion proof flow monitor for meter mount

### Specifications

Display	Dimensions	Ø 2.56 × 1.77 in. (65 × 45 mm)
	Digits	Seven 12 mm (0.47 in) and eleven 7 mm (0.28 in) digits. Various symbols and measuring units
	Refresh rate	User definable: 8 times/sec – 30 sec
	Speedometer	To indicate the actual flow rate, the bar graph range is 0 – 100% in 20 blocks, each block is 5%
Hazardous area	CSA c-us / FM	Class I, Division 1, Grps A, B, C, D
		Class II/III, Division 1, Grps E, F, G
		Class I, Zone 1, AEx d IIC T6/T5 Gb
		Zone 21, Aex tb IIIC T85°C/T100°C Db
Input	Pulse flow meter	Coil / sine wave, NPN, PNP, reed switch, NAMUR, active pulse signals 8 or 24V DC
Outputs	Digital output	One passive transistor output
	Analog output	loop powered, 4 – 20 mA output
Ambient operating temperature		-40 up to +70° C (-40 up to +158° F)
Enclosure rating		NEMA 4X, NEMA 7, NEMA 8, NEMA 9, IP66, IP67
Power requirements		Battery powered
		Loop powered 11 – 27V DC
		Power supply 9 – 27V DC

### Part number: E110-P-AH-CX-HAA-IB-OT-PB-PD-XD-ZB

Code	Description	
<b>P</b>	Input signal	Pulse input: coil, npn, pnp, namur, reed-switch
<b>AH</b>	Analog output signal	Galvanic isolated, loop powered, 4-20mA output
<b>CX</b>	Communications	No communication
<b>HAA</b>	Enclosure	Aluminum Ex d enclosure - IP66 / IP67 drilling 2x3/4"NPT/1x1"NPT
<b>IB</b>	Additional input	Remote control input to reset total
<b>OT</b>	Digital output	Passive transistor output
<b>PB</b>	Additional battery supply	Lithium battery powered
<b>PD</b>	Power requirement	9-27 V DC with sensor supply
<b>XD</b>	Hazardous area	Explosion proof according to ATEX, IECEx, FM and CSA c-us
<b>ZB</b>	Backlight	Included

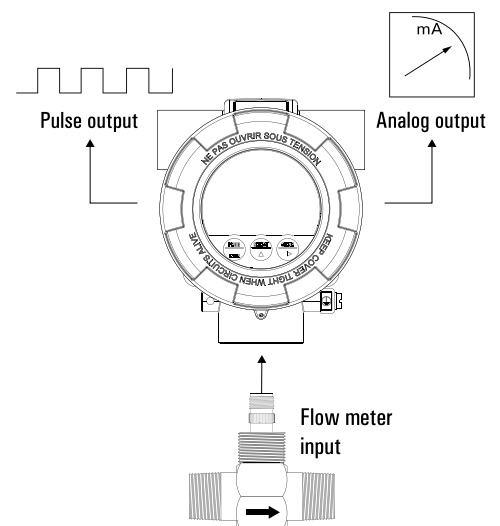

Please note: Remote version with cables is not available, needs to be supplied locally

Table 47

# Accessories



- Square-wave output proportional to any desired unit of measure
- Amplifies turbine meter output
- Windows®-based configuration software

## K-factor scalars

The Blancett® K-factor scaler converts a low level frequency output (such as that from a Blancett® turbine flow meter) into a scaled square wave digital output signal. This adjustable frequency divider converts or scales the turbine

meter output into units of measurement needed for a particular application and recognized by almost any data collection device. The k-factor scaler provides an amplified signal, even when a frequency conversion is not required. The signal

is more immune to electrical noise and capable of transmission over longer distances than a raw turbine meter output.

## Specifications

External power	Input voltage	8.5 – 30V DC (diode protected)
	Maximum current draw	18 mA (using internal resistor @ 30V DC input)
Inputs (magnetic pickup)	Frequency range	0 – 4000 Hz
	Trigger sensitivity	30 mV p-p – 30V p-p
Output signal	Max. voltage	30V DC
	Max. power	0.25 W
Pulse output (using internal pullup resistor)	Maximum Current	8 mA
	VH =	Power input voltage – 0.7V DC
	VL =	Less than 0.4V @ maximum input power
	Internal Pullup Resistor	3.6 kΩ (enabled/disabled by jumper)
Pulse output (using external pullup resistor)	Maximum Current	100 mA
	VH =	Input voltage to external pullup resistor
	VL =	$[VH / (\text{selected resistor value} + 47 \Omega)] \times 47 \Omega$
	Pulse length	150 μs, 1 ms, 25 ms, 100 ms, 500 ms, 1 s, or auto mode
Approvals	CSA	Ordinary locations
		CAN/CSA C22.2 No. 61010-1-12, UL Std. No. 61010-1 (3rd edition)
	Pollution degree 2	Overvoltage category I
Enclosure	Killark aluminum capped elbow Y-3. Class I, Div. 1 & 2, Groups C & D; Class II, Div. 1 & 2, Groups E, F and G; Class III	
Operating temperature	-30 to +70 °C (-22 to +158 °F)	

## K-factor scaler (digital)

Part number	Description
B220-880	K-factor scaler, rotary switch in conduit outlet box side entry
B220-881	K-factor scaler, rotary switch in conduit outlet box bottom entry
B220-882	K-factor scaler, rotary switch in conduit outlet box side and bottom entry
B220-885	K-factor scaler, programmable input in aluminum-capped elbow
B220-900	K-factor scaler software/cable package (for use with B220-885 only)

Table 48



B220-880



B220-881



B220-882



B220-885

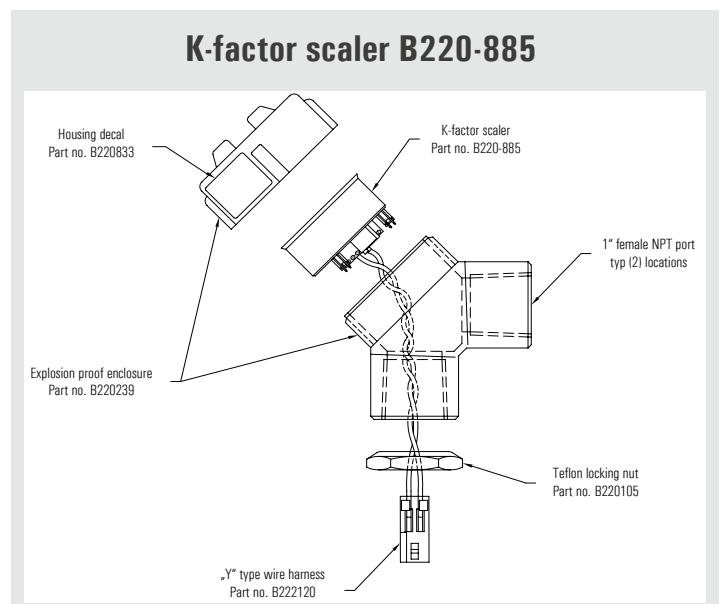
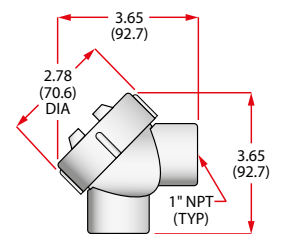
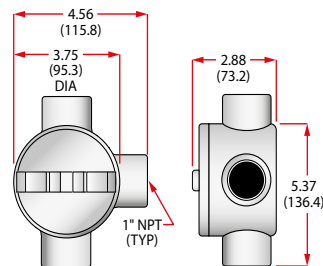
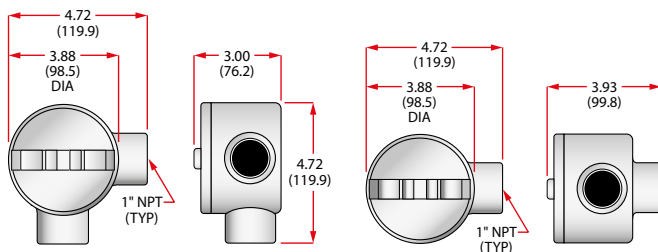



- 4–20 mA (2-wire) or 0–5V DC (3-wire) output
- Analog signal proportional to flow rate
- Windows®-based configuration software

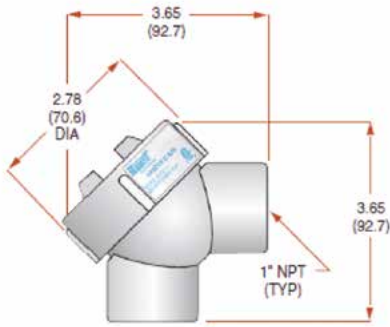

**Conduit elbow style**  
Model B220-873 & B220-874



**Canister style**  
Model B220-950 & B220-951

## Frequency converter

These microprocessor-based devices are engineered to provide an analog output directly from a Blancett® turbine flow meter. The converters measure and calculate the flow rate of a turbine flow meter and produce an analog output proportional to the flow rate.

The F to I and F to V converters with two different mounting styles are offered with either a 4–20 mA or a 0–5V DC output signal, enabling easy electronic integration.

Choose between the capped aluminum conduit elbow style (model B220-873 or B220-874) or the canister style (model B220-950 or B220-951).

## Specifications

Intelligent frequency converter		F to I Frequency-to-current Models B220-873 & B220-950	F to V Frequency-to-voltage Models B220-874 & B220-951
Inputs	Frequency	Magnetic Pickup 0–3500 Hz	Magnetic Pickup 0–3500 Hz
	Trigger Sensitivity	30 mV p-p	30 mV p-p
	Frequency Measurement Accuracy	±0.1%	±0.1%
Analog Output	Resolution	4–20 mA current loop 1 : 4000	0–5V DC 1 : 4000
	Temperature Drift	50 ppm/°C (max)	50 ppm/°C (max)
Environmental	Ambient Temperature	-30 up to 70 °C (-22 up to 158 °F)	-30 up to 70 °C (-22 up to 158 °F)
	Humidity	0–90%, non-condensing	0–90%, non-condensing
Power		10–30V DC supply Loop-powered	10–26V DC supply



## Intelligent frequency converter (analog)

Part number	Description
B220-873	F to I intelligent converter, 4-20 mA output in aluminum-capped elbow
B220-874	F to V intelligent converter, 0-5 VDC output in aluminum-capped elbow
B220-950	F to I intelligent converter, 4-20 mA output in canister (includes magnetic pickup)
B220-951	F to V intelligent converter, 0-5 VDC output in canister (includes magnetic pickup)
B220-954	F to I / F to V programming kit for B220-873 and B220-874
B220-953	F to I / F to V programming kit for B220-950 and B220-951

NOTE: B220-873, B220-874 require magnetic pickup B111109

Table 49

## Preamplifier (digital)

Part number	Description
B220-290	Preamplifier, 10 V square wave output
B220-262	Preamplifier, 10 V square wave output in aluminum conduit enclosure
B222228	Preamplifier, RF; 12/24 VDC for 1200, CorrExx™ series only

Table 50

## Magnetic pickups

The Blancett® pickup is a magnetic pickup used with turbine flow meters to sense movement of the rotor blade within the flow meter body. The pickup is available in two connections: a two-pin connection, or a three-pin sealed stainless steel

face connection for sanitary applications. The contents of the pickup are sealed in a rugged stainless steel housing that can be used with a variety of threaded turbine flow meters.

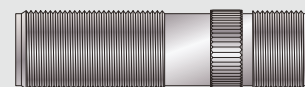

B111109, B111128, B111129

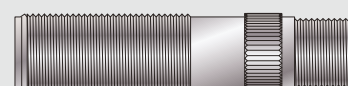

B161109

Part number	Description
B110125	Jam nut for all magnetic pickups (except B111117, B140013 and B120101)
B111109	Standard magnetic pickup -101 °C to +165 °C (-150 °F to +330 °F)
B111112	T2 magnetic pickup, 12" leads +107 °C (+225 °F)
B111113	Gas QuikSert® magnetic pickup -101 °C to +149 °C (-150 °F to +300 °F)
B111117	Standard RF pickup -101 °C to +165 °C (-150 °F to +330 °F) for 1200, CorrExx™ series only
B111126	Magnetic pickup, ATEX approved (European hazardous area)
B111127	Magnetic pickup, length 3", -101 °C to +165 °C (-150 °F to +330 °F)
B111128	Magnetic pickup, length 4", -101 °C to +165 °C (-150 °F to +330 °F)
B120101	Magnetic pickup, all stainless steel, long nose for 1200, CorrExx™ series only
B140013	Shielded magnetic pickup, stainless steel for 1200, CorrExx™ series only
B161109	NEMA 6 magnetic pickup -101 °C to +165 °C (-150 °F to +330 °F)
B161210	NEMA 6 magnetic pickup with preamplifier -29 °C to +71 °C (-20 °F to +160 °F)
B161211	Magnetic pickup, open collector-open emitter
B161212	NEMA 6 magnetic pickup with preamplifier (less Zener)
B220111	High temp magnetic pickup -101 °C to +232 °C (-150 °F to +450 °F)
B220210	Magnetic pickup with preamplifier -29 °C to +71 °C (-20 °F to +160 °F)
B220243	Intrinsically safe magnetic pickup, FM rated -40 °C to +121 °C (-40 °F to +250 °F)

Table 51

## Cable and connector options

Used with magnetic pickups **B111109**, **B111113**, **B111117**, **B111127**, **B111128**, **B120101**, **B140013** and **B220243**

Part number	Description
B220-220	Cable assembly; 3 m with 2 pin 90 °Connector
B220-221	Cable assembly; 3 m with 2 pin straight connector
B220-221-X	Cable assembly; 3 m with 2 pin straight connector & stripped leads
B220-221-XLC	Cable assembly; 3 m with 2 pin straight connector, hub protector, & stripped leads
B220-218	Cable assembly; 3 m with 2 pin straight connector and hub protector
B222-124	Connector assembly; 2 pin Amphenol, 90°
B222-126	Connector assembly; 2 pin amphenol, straight
B220229	Cable; 2-wire, 22 GA standard, additional footage
Extra cable	For cable assembly with added length, specify footage after standard part number (example: 15 feet = 4,5 m = B220-220-15)

Table 52

## Cable and connector options

Used with magnetic pickup with preamplifier **B220210**

Part number	Description
B220-219	Cable assembly; 3 m with 3 pin connector
B220-217	Cable assembly; 3 m with 3 pin and hub protector
B222-127	Connector assembly; 3 pin amphenol
B002203	Cable; 3-wire 18 gauge, additional footage (priced per foot)

Table 53

## Cable and connector options

Used with high temperature magnetic pickup **B220111**

Part number	Description
B220-090	Cable assembly; 3 m high temp cable with 2 pin straight connector
B120-003	Cable assembly; 3 m Teflon® with 90 °Connector
B220087	Cable; high temp 2-wire Teflon®

Table 54

## Cable and connector options

Used with active pickups **B220-950** and **B220-951**

Part number	Description
B220952-6	Cable assembly; 1,8 m with 5 pin straight connector
B220952-15	Cable assembly; 4,5 m with 5 pin straight connector

Table 55

## Cable and connector options

Used with NEMA 6 pickups B161109 and B161210

Part number	Description
B160206	Cable assembly; 1,8 m with NEMA 6, 3 pin 90° connector for sanitary applications
B160212	Cable assembly; 3,6 m with NEMA 6, 3 pin 90° connector for sanitary applications
B160220	Cable assembly; 6 m with NEMA 6, 3 pin 90° connector for sanitary applications
B160224	Cable assembly; 7,3 m with NEMA 6, 3 pin 90° connector for sanitary applications
B160240	Cable assembly; 12 m with NEMA 6, 3 pin 90° connector for sanitary applications
B160250	Cable assembly; 15 m with NEMA 6, 3 pin 90° connector for sanitary applications

Table 56

## Cable and connector options

Used with magnetic pickups B161211 and B170210

Part number	Description
B160512	Cable assembly; 3,6 m with NEMA 6P, 5 pin 90° connector
B160520	Cable assembly; 6 m shielded with NEMA 6, 5 pin straight connector

Table 57

## Bushing reducer

Part number	Description
B220056	1" x ½" NPT bushing, plastic
B220057	1" x ½" NPT bushing, metal

Table 58

## Explosion proof kit (hazardous location)

Part number	Description
B280-737	For 1" NPT Hub for remote mount display B30X or B2800XP
B280-742	For ½" NPT Hub for remote mount display B30X or B2800XP

Table 59

# Appendix

## Example 5 point calibration protocol for liquid flow meters



8635 Washington Ave  
 Racine, WI 53406  
 262-639-6770 | 800-876-3837  
 www.badgermeter.com

### Calibration Report

**Unit Under Test (UUT) Information:**

**Description:** 1" NPT, Turbine Flow Meter  
**Model Number:** B1111-110  
**Serial Number:** 021501A112  
**Sensor Type:** Magnetic Pickup  
**Output type:** Frequency  
**Minimum Flow:** 5 GPM 18.9 LPM  
**Maximum Flow:** 50 GPM 189.3 LPM  
**Calibration Date:** January 6, 2015  
**Calibration Interval:** 12 Months  
**Cal. Liquid:** Water  
**Ambient Temperature:** 72.62 °F  
**Ambient Humidity:** 40.14 %RH  
**Linear Points:** 5

**Master Meter:**

**Std uncertainty:** ±0.25%  
**Traceability No:** TFM-1956 / TFM-1958  
**Model No:** Optiflux 4000 Mag Flowmeter  
**Serial No:** A0928610 / A0906248  
**Re-Cal Date:** 03.04.2015

**Customer Information:**

**Customer Name:** John Doe  
**Customer PO:** 25391932  
**Order No:** C2-050712

**UUT Calibration Data Table In GPM:**

Flow Standard	Actual GPM	UUT Hz	UUT Temp °F	Visc. cSt	UUT F/V Hz/cSt	UUT K CYC/GAL	(Hz*60)/NK GPM	Linear COEFF.	Raw Err % Rate
2	50,07	733,800	68,60	0,995	737,654	879,33	50,05	1,0004	0,04
2	28,10	411,400	69,10	0,988	416,492	878,43	28,06	1,0014	0,14
2	15,83	232,700	69,00	0,989	235,248	882,00	15,87	0,9974	-0,26
2	8,83	129,700	69,00	0,989	131,120	881,31	8,85	0,9982	-0,18
2	5,04	73,700	68,90	0,991	74,402	877,38	5,03	1,0026	0,26

Nominal K (NK) 879,688

**UUT Calibration Data Table In LPM:**

Flow Standard	Actual LPM	UUT Hz	UUT Temp °F	Visc. cSt	UUT F/V Hz/cSt	UUT K Cyc/Liter	(Hz*60)/NK LPM	Linear COEFF.	Raw Err % Rate
2	189,54	733,800	68,60	0,995	737,654	232,29	189,46	1,0004	0,04
2	106,37	411,400	69,10	0,988	416,492	232,06	106,22	1,0014	0,14
2	59,92	232,700	69,00	0,989	235,248	233,00	60,08	0,9974	-0,26
2	33,43	129,700	69,00	0,989	131,120	232,82	33,49	0,9982	-0,18
2	19,08	73,700	68,90	0,991	74,402	231,78	19,03	1,0026	0,26

Nominal K (NK) 232,389

<b>Status:</b>	PASS
<b>Meter Accuracy (of Rate):</b>	± 0.26 %
<b>Average Calib. Temperature :</b>	68.9 F
<b>Average Calib. Specific Gravity :</b>	1
<b>Average Calib. Viscosity :</b>	0.99 cSt
<b>Flow Direction :</b>	Forward

Calibrated By: \_\_\_\_\_

Certified By: \_\_\_\_\_

Calibrations are performed using standards traceable to the National Institute of Standards and Technology  
 The equipment and calibration procedure complies with ISO 9001:2008  
 This calibration report may not be reproduced, except in full, without the written approval from Badger Meter Inc.

## Example 5 point calibration protocol for gas flow meters



8635 Washington Ave  
Racine, WI 53406  
262-639-6770 | 800-876-3837  
www.badgermeter.com

### Calibration Report

#### Unit Under Test (UUT) Information:

**Description:** 2" Mid-Flow Gas Turbine Flow Meter  
**Model Number:** B142-20M  
**Serial Number:** 021701A900  
**Sensor Type:** Magnetic Pickup - Low Drag  
**Output type:** Frequency  
**Minimum Flow:** 14 ACFM  
**Maximum Flow:** 140 ACFM  
**Calibration Date:** January 6, 2017  
**Calibration Interval:** 12 Months  
**Cal. Fluid:** Air  
**Ambient Temperature:** 74.34 °F  
**Ambient Humidity:** 9.22 %RH  
**Test Points:** 5

#### Master Meter(s):

**Flow Systems Sonic Nozzles**  
**Uncertainty:** ±0.5%

#### Standard Serial No.

1 22891  
2 22892  
3 22893  
4 22894  
5 22895  
6 22896  
7 22897

#### Customer Information:

**Customer Name:** John Doe  
**Customer No.:** 12345  
**Order No.:** 54321

#### UUT Calibration Data Table In ACFM:

Standard	Master Flow Rate (ACFM)	UUT						Linear COEFF.	Error % Rate
		Hz	UUT Temp °F	Re	UUT K CYC/ACFM	(Hz*60)/NK ACFM			
3	14.00	42.366	72.20	10,633	181.51	14.20	0.9861	-1.41	
4	51.80	155.142	71.67	39,395	179.70	52.01	0.9961	-0.40	
4	77.03	228.800	71.42	58,630	178.22	76.70	1.0043	0.43	
5	102.28	300.838	71.18	77,912	176.47	100.84	1.0143	1.41	
5	140.17	413.831	70.78	106,901	177.15	138.72	1.0104	1.03	

Nominal K (NK) 178.991

<b>Status:</b>	PASS
<b>Meter Accuracy (of Rate):</b>	± 1.41 %
<b>Average Calib. Temperature :</b>	71.5 F
<b>Average Calib. Specific Gravity :</b>	1
<b>Average Viscosity: (cP)</b>	0.0182
<b>Flow Direction :</b>	Forward

Calibrated By: \_\_\_\_\_ Date: \_\_\_\_\_

Certified By: \_\_\_\_\_ Date: \_\_\_\_\_

The meter referenced above was calibrated using standards traceable to the United States National Institute of Standards and Technology, NIST. The equipment and calibration procedure (BAS-405-001) complies with ISO 9001:2008. This certification was performed by Badger Meter Inc. and conducted with AIR. This report may not be reproduced, except in full, without the written approval of Badger Meter Inc.

- Offices
- Distributors



## Customer accessibility and competence

We can help you in a timely manner to solve your measurement problems, advising you to assist in optimizing your measurement solution, technology and site location before you make a decision. An extensive distributor and service network ensures the best service worldwide.

Local representatives are a big advantage for our customers. The short distance and local language support provide efficient service. Our distributors are trained on Badger Meter products at their own facilities or in our training center. Our name assures you that our products have been manufactured with the best care and in conformity with all DIN ISO 9001:2015 directives.

**Tel. 0800 588 897 801**  
**Service hotline free of charge within Germany**



You can reach us within Germany free of charge on 0800-588 897 801.

**From outside Germany**

Phone +49-7025 9208-0

**Monday through Friday**

8.00 – 12.00 and 13.00 – 17.00 (CET)



# Product line overview

Electromagnetic flow meters  
Ultrasonic flow meters  
Weirs and flumes  
Turbine meters  
Oscillating piston meters  
Nutating disc meters  
Impeller meters  
Vortex meters  
Variable area flow meters  
Differential pressure flow meters  
Venturi tubes  
Mass meters  
Heat meters  
Hydraulic testers  
Flow calibrators  
Lubrication meters  
Oil management systems  
Control valves  
Concrete finishing products



**Badger Meter Europa**

## **Badger Meter Europa GmbH**

Nürtinger Str. 76  
72639 Neuffen  
Germany  
Tel. +49-70 25-92 08-0  
Fax +49-70 25-92 08-15  
badger@badgermeter.de  
www.badgermeter.de

For Switzerland  
**Badger Meter Swiss AG**  
Mittelholzerstr. 8  
3006 Bern  
Switzerland  
Tel. +41 31 932 01 11  
Fax +41 31 931 08 67  
info@badgermeter.ch  
www.badgermeter.ch

For the USA and Americas  
**Badger Meter, Inc.**  
P.O. Box 245036  
Milwaukee, WI 53224-9536  
USA  
Tel. +1-414-355-04 00  
Fax +1-414-355-74 99  
infocentral@badgermeter.com  
www.badgermeter.com

For Asia  
**Badger Meter Europa GmbH  
Singapore Branch**  
80 Marine Parade Road  
#21-06 Parkway Parade  
Singapore 449269  
Singapore  
Tel. +65-63 46 48 36  
Fax +65-63 46 48 37  
awang@badgermeter.com

For Slovakia and  
the Czech Republic  
**Badger Meter Slovakia s. r. o.**  
Racianska 109/B  
83102 Bratislava  
Slovakia  
Tel. +421-2-44 63 83 01  
Fax +421-2-44 63 83 03  
badgermeter@badgermeter.sk  
www.badgermeter.sk

For the United Arab Emirates  
**Badger Meter Europe  
Middle East Branch Office**  
Dubai Silicon Oasis  
Head Quarter Building  
Wing C, Office #C209  
Dubai / UAE  
Tel. +971-4-371 2503  
Fax +971-4-371 2504  
gramaswamy@badgermeter.com

For Mexico  
**Badger Meter de las  
Americas S. A. de C. V.**  
Pedro Luis Ogazon #32  
Col. Guadalupe Inn  
Mexico, D. F. 01020  
Mexico  
Tel. +52-55-56 62-08 82  
Fax +52-55-56 62-75 81  
bmdla@badgermeter.com

For China  
**Badger Meter, Inc.  
Shanghai Representative  
Office 7-1202**  
99 Hangzhong Road  
Minhang District  
Shanghai 201101  
China  
Tel +86-21-57 63-54 12  
Fax +86-21-57 63-54 12  
rjiang@badgermeter.com

For Poland, Ukraine, Belarus  
and the Baltic countries  
**Badger Meter Europe  
Eastern Europe Branch Office**  
ul. Korfantego 6  
44-193 Knurów / Poland  
Tel. +48-32 236 744 7  
biuro@badgermeter.com  
www.badgermeter.de

TUR\_BLC\_KAT\_02\_1801 Due to continuous research, product improvements and enhancements, Badger Meter reserves the right to change product specifications without prior notice.



Every drop counts.