



Main characteristics (20 °C)

Measuring range	-1.0 ... 400.0 bar
Minimum range	50 mbar
Turn down	10:1
Long term stability	<0.1 % FS / Year
Accuracy (Linearity, hysteresis and repeatability)	<±0.1 % FS / <±0,25 % FS
Standard process temperature	Standard oil -40...125 °C (<150 °C <60 min) NSF H1 listed oil (FDA approved) -5 ... 125 °C (<150 °C <60 min)
Max. process temperature	200 °C (with cooling neck)

Technical specification

Measuring principle	Piezoresistive silicon sensor
Measuring ranges	-1 ... 0 bar up to 0 ... 400 bar,
Min. range	0 ... 0.05 bar, programmable
Type of pressure	Relative / Absolute
Turn down	10:1 FS
Accuracy (Linearity, Hysteresis, Repeatability)	0.1% FS@20°C up to 2:1 turn down 0.25% FS@20°C up to 4:1 turn down
Zero thermal drift	≤ ± 0.005 % FS/°C
Span thermal drift	= ± 0.005 % FS/°C
Annual stability, IEC 770 6.3.2	0.1 % FS / Year
Response time (10 ... 90%)	≤ 0.3 sec.
Sample time	≤ 0.3 sec.
Start up time	<10 sec.
Process connections	See page 3

Main features

- Flush diaphragm
- Built in graphical display, CombiView™ DFON optional
- HART®
- ATEX
- Programmable by touch screen
- Easy and full programmable with FlexProgrammer 9701

Applications

- Oil and Gas
- Chemical
- Energy
- General process industry

Environment

Temperature	
Storage	-40 ... +85 °C
Media (without cooling neck)	-40 ... +125 °C
Short term (SIP)	150 °C for 60 min.
Media (with cooling neck)	-40 ... +200 °C
Ambient	-40 ... +85 °C
Protection rating, IEC 529	IP67 / IP69K, depending on electrical connection
Humidity, IEC 68-2-38	98 %, condensing
Vibration	DNV high vibration strain, class B 1.6 mm 2 ... 25Hz IEC60068-2-6, test FC 25 ... 100 Hz, 4.0 g

Electrical specification

Output signal	4...20 mA, 20...4 mA, 4...20 mA HART®
Power Supply	10 ... 35 VDC
Load impedance	$R_Q = (U_{supply} - 10 V) / 20 mA$
Insulation resistance	>100 MΩ at 500 V
Sensor failure	Configurable, 3.6...4 or 20...23 mA
Electrical connections	M12 connector in stainless steel M16 or M20 cable gland in plastic or stainless steel

ATEX ia Gas / Dust

Approval	Gas Zone 0/1 Dust Zone 20/21	
Voltage drop	U_{Disp}	4.5 or 6.5 VDC
T° class	T1 ... T5	Zone 0 and 20 -20 °C ... 60 °C Zone 1/2 and 21/22 -40 °C ... 65 °C
Internal inductivity	L_i	< 10 µH
Internal capacity	C_i	< 15 nF
Barrier data	U_i	< 30 VDC
	I_i	< 0.1 A
	P_i	< 0.75 W

ATEX nA Gas

Approval	Gas Zone 2	
Voltage drop	U_{Disp}	4.5 or 6.5 VDC
T° class	T1 ... T5	-30 < Tamb < 65 °C
Internal inductivity	L_i	< 10 µH
Internal capacity	C_i	< 15 nF
Max. voltage	U_{max}	< 35 VDC
Max. current	I_{max}	< 0.1 A

Display specifications

Type	Graphically LCD
Front glass	Polycarbonate
Display modes	9 modes, programmable, e.g. value, bar graph, analogue, tank illustration, data logging display
Background	White, green, red - programmable
Measuring range	-9999 ... 99999
Digit height	Max. 22 mm
Accuracy	0.1% @ ambient -10 ... 70 °C
Voltage drop	<4 ... 6.5 VDC
Output	2 configurable relay output, 60 Vp, 75 mA
Programming	Touch screen or FlexProgrammer 9701

Further information can be found in separate data sheet for DFON

Material

Process connection	Stainless steel 1.4404 (AISI 316L)
Housing	Stainless steel 1.4301 (AISI 304)
Diaphragm	Stainless steel 1.4435 (AISI 316L)
Sealing	NBR, EPDM or FKM (Viton®)

Approvals

Apply to	EMC directive 2004/108/CE in accordance with EN61000-6-2, EN 61000-6-3 Pressure directive 97/23/CE
----------	---

Measuring ranges and over pressure safety

Pressure range	Pressure in bar						
	0.0 ... 0.345	-1.0 ... 1.0	-1.0 ... 5.0	-1.0 ... 20.0	-1.0 ... 34.0	-1.0 ... 68.0	-1.0 ... 400.0
Over pressure	1	3	15	60	70	135	690
Burst pressure	2	6	30	120	140	270	1350

Electrical connections

M12, 5-wire

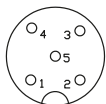

- 1 + supply, 4 ... 20 mA
- 2 Common for relays
- 3 - supply, 4 ... 20 mA
- 4 Relay 2
- 5 Relay 1

M12, 8-wire

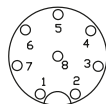

- 1 N.C.
- 2 + supply, 4 ... 20 mA
- 3 Relay 2
- 4 Relay 2
- 5 Relay 1
- 6 Relay 1
- 7 - supply, 4 ... 20 mA
- 8 N.C.

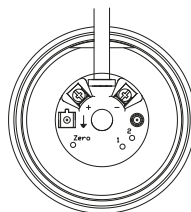

Cable gland

Transmitter

- 24VDC / - 4...20mA
- + 24VDC / +4...20mA
- Com 1 Red clip (FlexProgrammer)
- Com 2 Black clip (FlexProgrammer)

Display

- 1 N.C.
- 2 N.C.
- 3 Relay 2
- 4 Relay 2
- 5 Relay 1
- 6 Relay 1
- Com 1 Red clip (FlexProgrammer)
- Com 2 Black clip (FlexProgrammer)

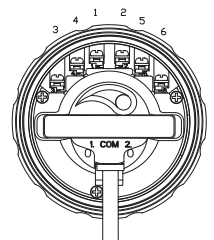

ATEX ia Gas/Dust

PFMx without relay output

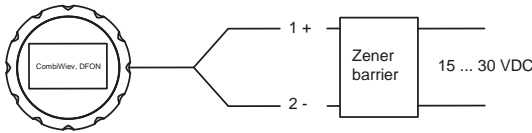

PFMx with relay output

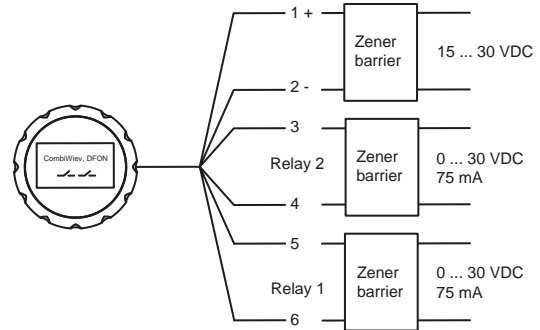

ATEX nA Gas

PFMx without relay output

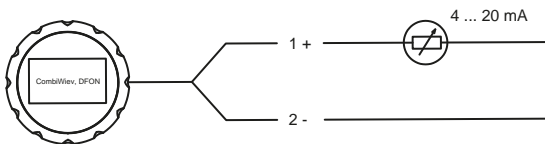

PFMx with relay output

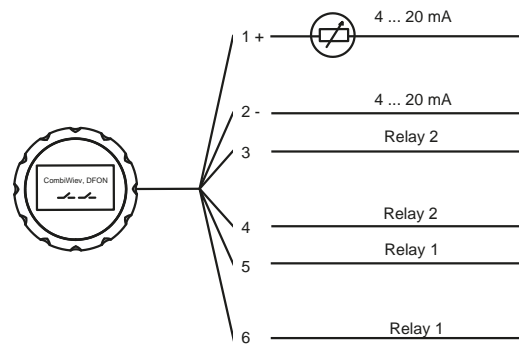

Dimensions (mm)

Front view

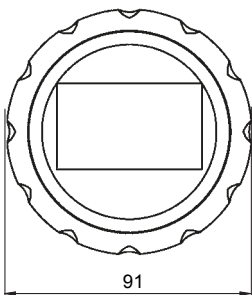

Bottom connection

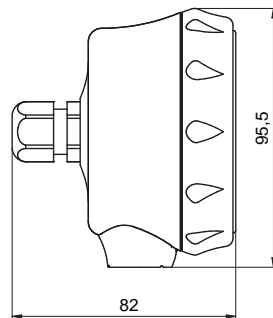

Rear connection

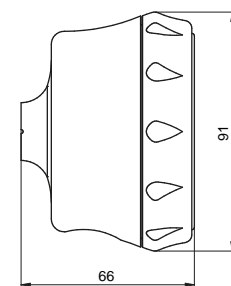

Process connections dimensions (mm)

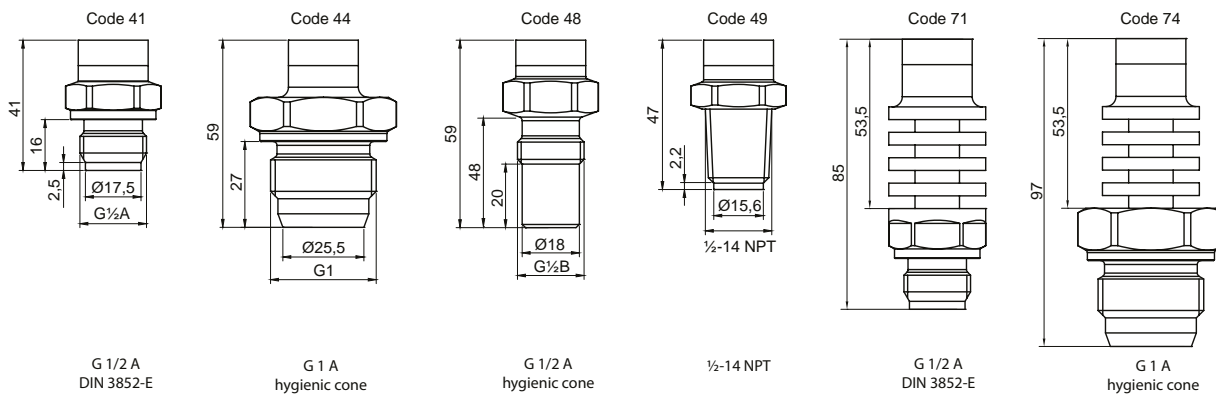

Ordering details

	-	x	x.	xxx	x.	xx	xx	x.	xx	x	x	x.	x	x	x	x
Model																
CombiPress™																
	PFMN															
Housing																
Stainless steel 1.4301 (AISI 304) Bottom connection																5
Stainless steel 1.4301 (AISI 304) Rear connection																6
Accuracy																
±0.25 %																4
±0.10 % (not range 0.345 mbar)																5
Pressure range and unit																
Min. 0.0 / max. 0.345 bar (no abs.) (all process connections other than 48, 49)																BC1
Min. -1.0 / max. 1.0 bar (0...1 bar abs.)																BC2
Min. -1.0 / max. 5.0 bar (0...5 bar abs.)																BC3
Min. -1.0 / max. 20.0 bar (0...20 bar abs.)																BC4
Min. -1.0 / max. 34.0 bar (0...34 bar abs.)																BC5
Min. -1.0 / max. 68.0 bar (0...68 bar abs.)																BC6
Min. -1.0 / max. 400.0 bar (0...400 bar abs.) (for process connections code 41, 49, 71)																BC7
Kind of pressure																
Relative																R
Absolute																A
Output signal																
4 ... 20 mA																A1
4 ... 20 mA + HART®																C1
Output connection																
M12, 5 pins																15
M12, 8 pins																18
Cable gland, M16																55
Cable gland, M20																57
Material of el. connection																
Plastic																1
Stainless steel 1.4301 (AISI 304)																3
Process connection																
G 1/2 A DIN 3852-E					BCID:		G51									41
G 1 A hygienic (1)					-		A04									44
G 1/2 A hygienic (1)					-		A03									48
1/2-14 NPT					-		N02									49
G 1/2 A DIN 3852-E with cooling neck					-		G51									71
G 1 A hygienic with cooling neck (1)					-		A04									74
Wetted parts material																
Stainless steel 1.4404 (AISI 316L)																2
Seal																
None (for connection code 44, 49, 48, 74)																0
NBR Standard (for connection code 41, 71)																1
EPDM (for connection code 41, 71)																2
FKM (Viton®) (for connection code 41, 71)																3
Oil filling																
Standard oil -40 ... 200 °C																1
NSF H1 listed oil (FDA approved) -5 ... 200 °C																2
Display																
Without display																1
With display. No relays activated																2
With display. With activated relays																4
ATEX																
Without																0
Ex nA II T5 (Gas)																3
Ex ia IIC T5 Ga / Ex ia IIIC T100 °C Da (Gas or Dust)																5
Approvals																
Without																0
Configuration																
No configuration (configured according to pressure cell)																0
Configuration of Range																1
Configuration of Range + Display																2

If the product wanted is not available from above list please inquire.
(1) ≤ 60 bar