

MODEL 1056 PROFIBUS DP ADDENDUM

For use with Model 1056 units installed with Communications option –DP (1056-0X-2X-3X-DP)

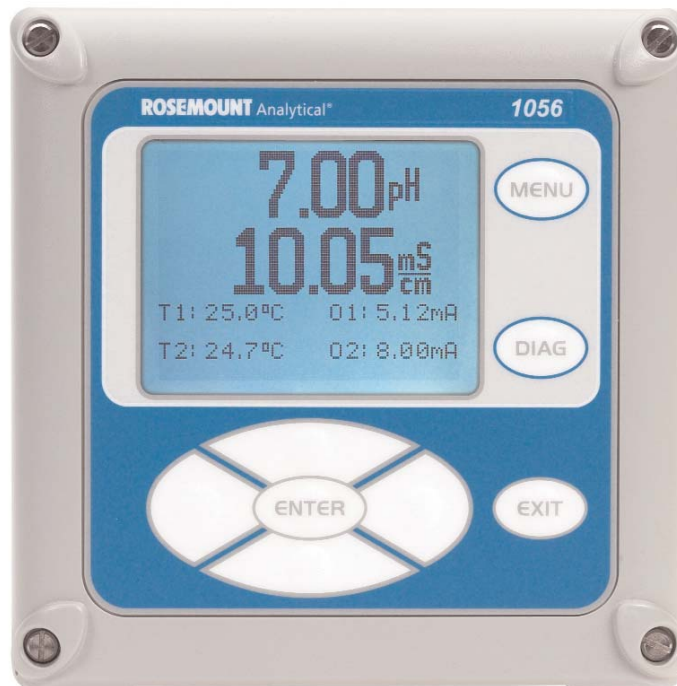

ESSENTIAL INSTRUCTIONS

READ THIS PAGE BEFORE PROCEEDING!

Your instrument purchase from Rosemount Analytical, Inc. is one of the finest available for your particular application. These instruments have been designed, and tested to meet many national and international standards. Experience indicates that its performance is directly related to the quality of the installation and knowledge of the user in operating and maintaining the instrument. To ensure their continued operation to the design specifications, personnel should read this manual thoroughly before proceeding with installation, commissioning, operation, and maintenance of this instrument. If this equipment is used in a manner not specified by the manufacturer, the protection provided by it against hazards may be impaired.

- Failure to follow the proper instructions may cause any one of the following situations to occur: Loss of life; personal injury; property damage; damage to this instrument; and warranty invalidation.
- Ensure that you have received the correct model and options from your purchase order. Verify that this manual covers your model and options. If not, call 1-800-854-8257 or 949-757-8500 to request correct manual.
- For clarification of instructions, contact your Rosemount representative.
- Follow all warnings, cautions, and instructions marked on and supplied with the product.
- Use only qualified personnel to install, operate, update, program and maintain the product.
- Educate your personnel in the proper installation, operation, and maintenance of the product.
- Install equipment as specified in the Installation section of this manual. Follow appropriate local and national codes. Only connect the product to electrical and pressure sources specified in this manual.
- Use only factory documented components for repair. Tampering or unauthorized substitution of parts and procedures can affect the performance and cause unsafe operation of your process.
- All equipment doors must be closed and protective covers must be in place unless qualified personnel are performing maintenance.



WARNING RISK OF ELECTRICAL SHOCK

- Equipment protected throughout by double insulation.
- Installation and servicing of this product may expose personnel to dangerous voltages.
- Main power wired to separate power source must be disconnected before servicing.
- Do not operate or energize instrument with case open!
- Signal wiring connected in this box must be rated at least 240 V.
- Non-metallic cable strain reliefs do not provide grounding between conduit connections! Use grounding type bushings and jumper wires.
- Unused cable conduit entries must be securely sealed by non-flammable closures to provide enclosure integrity in compliance with personal safety and environmental protection requirements. Unused conduit openings must be sealed with NEMA 4X or IP65 conduit plugs to maintain the ingress protection rating (NEMA 4X).
- Electrical installation must be in accordance with the National Electrical Code (ANSI/NFPA-70) and/or any other applicable national or local codes.
- Operate only with front panel fastened and in place.
- Proper use and configuration is the responsibility of the user.

CAUTION

This product generates, uses, and can radiate radio frequency energy and thus can cause radio communication interference. Improper installation, or operation, may increase such interference. As temporarily permitted by regulation, this unit has not been tested for compliance within the limits of Class A computing devices, pursuant to Subpart J of Part 15, of FCC Rules, which are designed to provide reasonable protection against such interference. Operation of this equipment in a residential area may cause interference, in which case the user at his own expense, will be required to take whatever measures may be required to correct the interference.

CAUTION

This product is not intended for use in the light industrial, residential or commercial environments per the instrument's certification to EN50081-2.

Emerson Process Management

Liquid Division

2400 Barranca Parkway
Irvine, CA 92606 USA
Tel: (949) 757-8500
Fax: (949) 474-7250

<http://www.raihome.com>

QUICK START GUIDE

Profibus

1. Refer to Model 1056 Instruction Manual, PN 51-1056 for installation instructions.
2. Ensure that the M12 interconnect cable is installed. See Section 3.0 for wiring instructions. Make, output, and power connections.
3. Once connections are secured and verified, apply power to the analyzer.

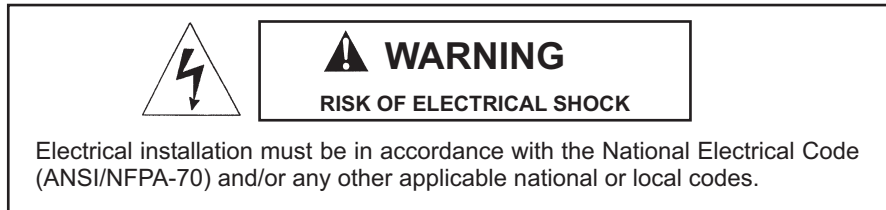

4. When the analyzer is powered up for the first time, **Quick Start** screens appear. Quick Start operating tips are as follows:
 - a. A **backlit** field shows the position of the cursor.
 - b. To move the cursor left or right, use the keys to the left or right of the ENTER key. To scroll up or down or to increase or decrease the value of a digit use the keys above and below the ENTER key. Use the left or right keys to move the decimal point.
 - c. Press ENTER to store a setting. Press EXIT to leave without storing changes. Pressing EXIT during Quick Start returns the display to the initial start-up screen (select language).
5. Complete the steps as shown in the Quick Start Guide flow diagram, Fig. A in the Model 1056 manual. All Profibus configured Model 1056 units include an additional step 5 during Quick Start (step 4 if AC line power does not appear):
 1. Choose local language
 2. Choose Measurement option
 3. Choose Temperature units
 4. AC line Power frequency (if applicable)
 5. Profibus Address

The Quick Start screen in step 5 appears as below:

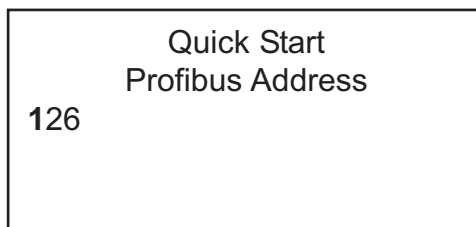

Enter a numeric Profibus network address from 000-125 for the Model 1056 Profibus device to be commissioned.

6. After the last step, the main display appears. The outputs are assigned to default values.
7. To change output, and temperature-related settings, go to the main menu and choose Program. Follow the prompts. For a general guide to the Program menu, see the Quick Reference Guide, Fig. B in the Model 1056 manual.
8. To return the analyzer to the default settings, choose Reset Analyzer under the Program menu.

About This Document

This manual contains instructions for installation and operation of the Model 1056 Dual-Input Intelligent Analyzer with Profibus DP digital communications. The following list provides notes concerning all revisions of this document.

<u>Rev. Level</u>	<u>Date</u>	<u>Notes</u>
A	1/08	This is the initial release of the product manual. The manual has been reformatted to reflect the Emerson documentation style and updated to reflect any changes in the product offering and is an Addendum to the Model 1056 manual.
B	9/08	FM and CSA agency approval, Class 1, Div 2.

Model 1056 Profibus DP

Instruction Manual Addendum

For use with Model 1056 units installed with –DP Communications ordering option **1056-0X-2X-3X-DP**

TABLE OF CONTENTS

QUICK START GUIDE
QUICK REFERENCE GUIDE
TABLE OF CONTENTS

Section	Title	Page
1.0	DESCRIPTIONS AND SPECIFICATIONS	1
1.1	General Specifications	1
1.2	Mechanical and Wiring Specifications.....	1
1.3	Environmental Specifications	1
1.4	Approvals	1
1.5	Other Specifications	1
2.0	INTRODUCTION TO PROFIBUS ADAPTOR AND PROFIBUS NETWORKS	2
2.1	Introduction to Model 1056 with PROFIBUS	2
2.2	Overview of PROFIBUS-DP	2
2.3	Introduction to PROFIBUS - General	3
3.0	INSTALLATION AND WIRING	5
3.1	Profibus Board	5
3.2	Wiring Directly to Profibus Network	6
3.3	Wiring to a Profibus Network with an M12 adapter cable assembly	8
4.0	PROGRAMMING PROFIBUS	11
4.1	Changing Profibus Address at the Device	11
5.0	DEVICE CONNECTION TO PROFIBUS NETWORK	12
5.1	Communications Architecture - Overview	12
5.2	Data Transmission	12
5.3	Device Database File (GSD file).....	13
6.0	PROFIBUS ACCESSORIES	15
6.1	Profibus network accessories	15
6.2	Model 1056 Profibus accessories	15
6.3	Spare Parts Table.....	16
7.0	PROFIBUS TROUBLESHOOTING	17
7.1	Profibus Diagnostics	17
7.2	Profibus Faults and Warnings	18
7.3	Troubleshooting Profibus Faults and Warnings	19

SECTION 1.0

DESCRIPTION AND SPECIFICATIONS

1.1 GENERAL SPECIFICATIONS

1.1.1 Profibus Slave (Station_Type =0)
Pure DP Device (FMS_supp =0)

1.1.2 Ten Baud Rates Supported:

9.6 kbps	(9.6_supp =1)
19.2 kbps	(19.2_supp =1)
45.45 kbps	(45.45_supp =1)
93.75 kbps	(93.75_supp =1)
187.5 kbps	(187.5_supp =1)
500 kbps	(500_supp =1)
1.5 Mbps	(1.5M_supp =1)
3 Mbps	(3M_supp =1)
6 Mbps	(6M_supp =1)
12 Mbps	(12M_supp =1)

1.1.3 Adding slave address via Profibus DP Enabled
(Set_Slave_Add_Supp =1)
Automatic transmission rate recognition supported
(Auto_Baud_supp =1)
Modular device (Modular_Station =1)
Max number of modules (Max_Module =29)

1.2 MECHANICAL AND WIRING SPECIFICATIONS

The Profibus DP-V1 communications board mounts in the digital communications card slot inside the Model 1056 (nearest the power supply board). A 10-lead flat ribbon cable connects the Profibus communications board to the mating connector labeled "DIG I/O" on the main board .

Interfacing to a Profibus DP network is made by connecting the 4-post connector on the left side of the Profibus board to the Profibus cable.

The Profibus board ships with a mating 4-position removable terminal block header.

Alternatively, Profibus-configured Model 1056 units can be wired to a Profibus network using an M12 adaptor cable assembly. The M12 adaptor cable assembly offered by Rosemount Analytical is an ordering option and is not provided with the Model 1056-DP unit.

The Profibus board provides isolated 5V for terminator power at the interface to the Profibus network.

1.3 ENVIRONMENTAL SPECIFICATION – 1056 INSTRUMENT WITH PROFIBUS DP CARD

- Ambient Temperature: 0 to 55 deg C
- Relative Humidity: 5 to 95 % (non condensing)
- Storage Temperature: -20 to 60 deg C

1.4 APPROVALS – 1056 INSTRUMENT WITH PROFIBUS DP BOARD (Models: 1056-0X-2X-3X-DP)

RFI/EMI: EN-61326

LVD: EN-61010-1



1.5 OTHER SPECIFICATIONS

1. Profibus board is detected by sensing resistance of 4.99k +/- 3% on DIG I/O connector between pins 8 and 1 (pin 8 to GND). Profibus is NOT present when resistance is outside specified range.
2. Station address provided by mainboard and preserved in NV memory during power down.
 - a. Station address may be remotely re-configured by a Bus Master device on the network.
 - b. Station address is pre-set to 126 at the factory (out of box default).
 - c. Profibus card uses station address 23 decimal if it is powered without an attached main board connection.
3. The Profibus board will operate continuously in an ambient temperature environment between 0C and +55C.
4. Profibus certification: The product is certified as a Profibus DP V0 and V1 Slave device.

SECTION 2.0

INTRODUCTION TO PROFIBUS ADAPTOR AND PROFIBUS NETWORKS

2.1 INTRODUCTION TO MODEL 1056 WITH PROFIBUS

2.2 OVERVIEW OF PROFIBUS-DP

2.3 INTRODUCTION TO PROFIBUS - GENERAL

2.1 INTRODUCTION TO MODEL 1056 WITH PROFIBUS

Profibus configurations of Model 1056 (1056-0X-2X-3X-DP) allow digital communications with a Profibus class 1 master to read measured process variables.

Profibus configured Model 1056 units support communications with a Profibus master using any combination of dual measurement inputs.

Profibus configured Model 1056 units include the following basic components:

1. A plug-in communications board in the card cage slot nearest the Power Supply
2. An M12 cable assembly and metal fitting for connection to the Profibus network (optional)
3. An IPL (Initial program load) for the 1056 main board to add Profibus functionality
4. RAI1056.GSD file for use with a Class 1 master. Must be downloaded from Rosemount Analytical web address: http://www.emersonprocess.com/raihome/liquid/products/AMS_FIELDDBUS.asp

2.2 OVERVIEW OF PROFIBUS-DP

Fieldbus networks are serial communication systems (see Figure 1) used to pass data signals between host systems and distributed peripheral equipment. The principal advantages of such a system are reduced cabling, commissioning and maintenance costs when compared with conventional architectures. A pair of wires is all that is required to transmit all the necessary signals (inputs, outputs, settings, diagnostics, etc.).

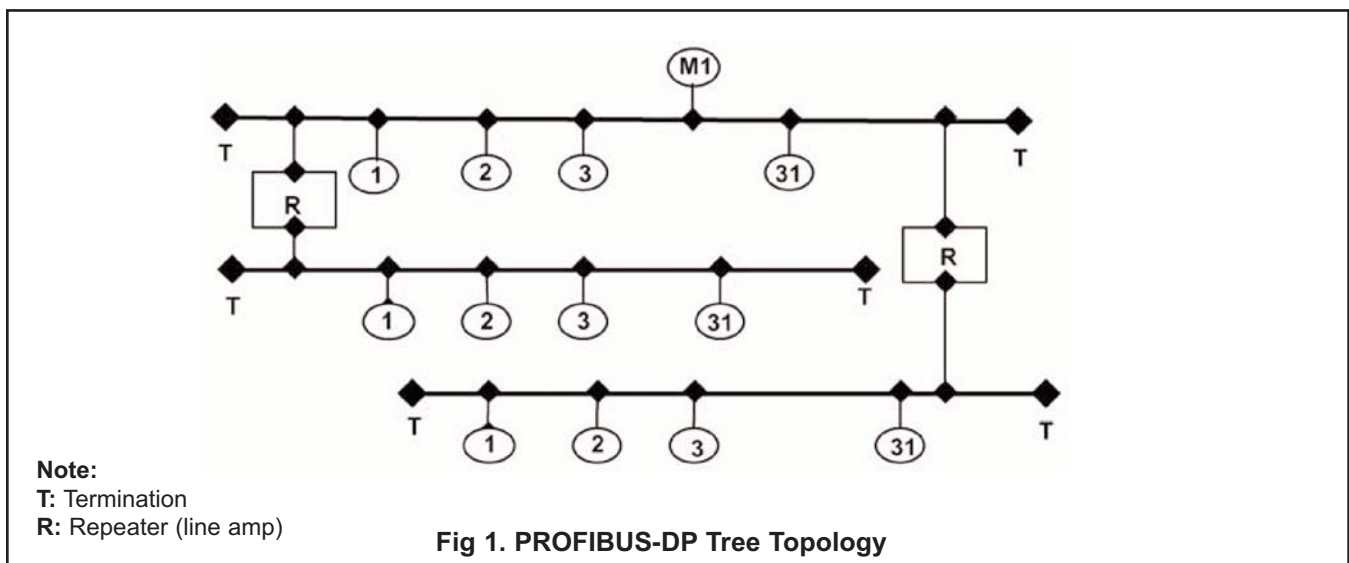

2.3 INTRODUCTION TO PROFIBUS - GENERAL

Profibus is an open FIELDBUS standard complying with the harmonized European standard EN 50170. It permits devices from different manufacturers to communicate with one another without the need for specialized interfaces. It may be used equally well for high speed, time critical data transmission or for transfers of large quantities of complex data signals.

Profibus exists in three versions or protocol architectures.

- **PROFIBUS-DP (Decentralized Periphery)**, is designed for communications between automation systems and distributed input/output (I/O) devices. It may be used to replace 24V or 0-20mA parallel transmission systems.
- **PROFIBUS-PA (Process Automation)** is designed to meet the specific needs of process engineering industries for use in explosion-proof and potentially explosive areas. Sensors and actuators are connected together on the same bus, including in dangerous within hazardous intrinsically safe zones. Both the signal data and the power signals travel over a two-wire link in compliance with International standard, IEC 1158-2.
- **PROFIBUS-FMS (Fieldbus Message Specification)** is primarily intended for cell management. Its sophisticated functions allow it to cover a wide range of applications. It may be used for both complex and high volume data exchanges.

SECTION 3.0

INSTALLATION AND WIRING

3.1 PROFIBUS BOARD

3.2 WIRING DIRECTLY TO A PROFIBUS NETWORK

3.3 WIRING TO A PROFIBUS NETWORK WITH AN M12 CABLE ASSEMBLY

This section outlines recommended methods of wiring Model 1056 units which include a Profibus DP digital communications board. The conventional method is to wire a standard purple Profibus cable directly to the instrument. Alternatively, Profibus-configured Model 1056 units can be wired to a Profibus network using an M12 adaptor cable assembly. The M12 adaptor cable assembly offered by Rosemount Analytical is an ordering option and is not provided with the Model 1056-DP unit. See Sec. 6.0 Profibus Accessories for parts ordering information. Additional accessories are also available to support necessary connections to a Profibus network and Profibus master.

3.1 PROFIBUS BOARD

Profibus-configured Model 1056 units (Model number 1056-0X-2X-3X-DP) include a pre-installed Profibus communications board and a ribbon cable. A 4-lead removable terminal block is installed on the Profibus board to allow wiring to a Profibus network.

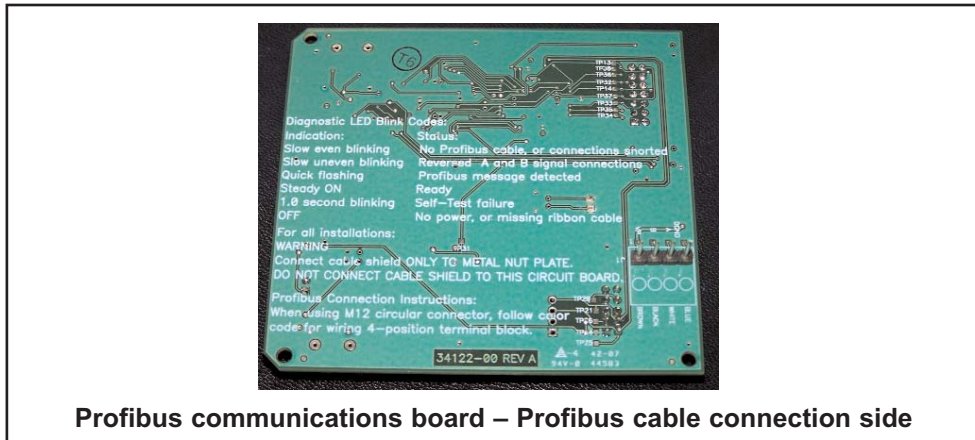

Profibus communications board – Profibus cable connection side

Profibus-configured Model 1056 units also include a pre-installed 10-lead ribbon cable that interfaces the communications board to the main PCB. Upon initial start-up, the Profibus communications board will be recognized by the main PCB microprocessor.

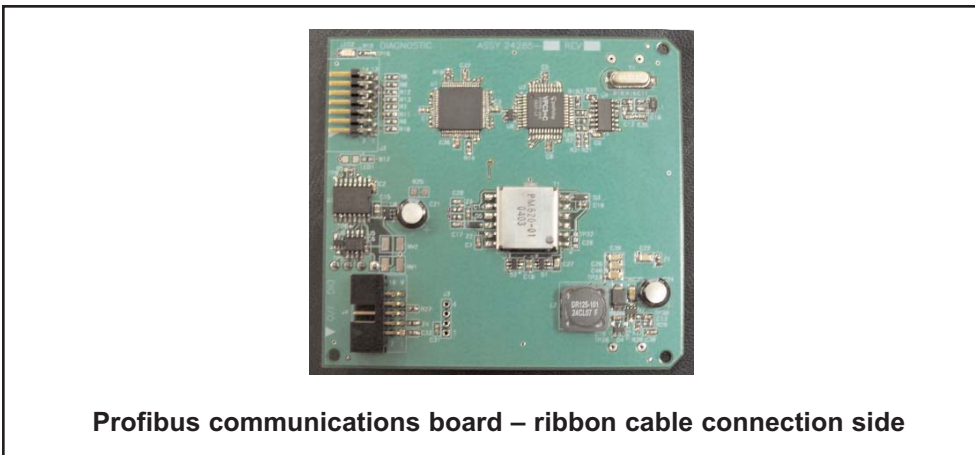

Profibus communications board – ribbon cable connection side

3.2 Wiring Directly To A Profibus Network

To connect a Profibus-configured Model 1056 to a Profibus network, the conventional method is to wire a standard purple Profibus cable directly to the Profibus board inside the instrument. The Profibus board is designed to accommodate direct wiring of a Profibus cable to a removable 4-lead terminal block on the Profibus board.

1. Feed the purple Profibus cable through a cable gland fitting. Install the cable gland fitting into the enclosure opening on the leftmost side of the enclosure nearest the front of the door hinge. See photo. Note that the power cable should be installed in the leftmost side of the enclosure farthest from the front of the door hinge – as shown in the photo below.



Proper enclosure opening locations for cable installation

2. Secure the purple Profibus cable with a cable gland fittings and nut from the outside of the enclosure to ensure a proper seal. Note that the cable gland fittings (PN 23554-00 - Cable Gland Kit, Quantity 5) does not require the securing nut inside the enclosure to properly install the fitting. Simply thread the fitting into the grounding plate inside the enclosure and tighten.

Once the gland fitting is tightly screwed into the enclosure and internal grounding plate, only the external nut needs to be tightened to properly seal the Profibus cable.

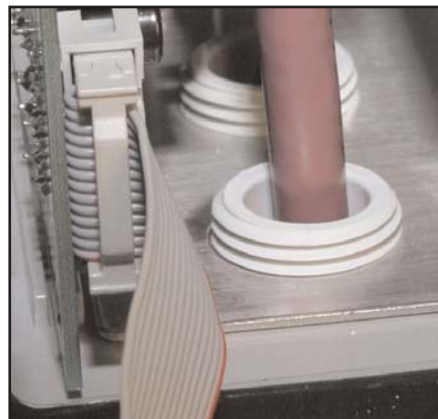

Cable gland fittings secured on internal grounding plate.

- Remove the 4-lead terminal block which is installed on the Profibus slide-in board. This photo shows the 4-lead terminal block installed onto the board.

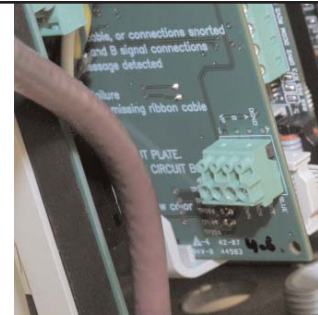

Profibus board showing removable 4-lead terminal block

- Wired the two leads of the purple Profibus cable (red and green) to the A and B positions of the 4-lead removable terminal block. A #0 Phillips head screw driver is required to open and close the terminal posts on the terminal block. The lead positions are labeled on the Profibus card (A and B) to assist in wiring.
Note: that Profibus wiring is polarity-sensitive. The Green color lead must be wired to lead position A. The Red color lead must be wired to lead position B.

Caution: Make sure the Profibus cable is properly prepared. Unshielded wire leads can lead to poor signal integrity from the Profibus device to the Master



Wiring Profibus cable to 4-lead terminal block

- After wiring the Profibus cable to the terminal block, slide the wired 4-lead terminal block onto the 4 pins protruding from Profibus board on the left side. Photo shows the 4-lead terminal block properly wired to the Profibus board and installed onto the board.

Note: the Profibus cable must be directed downwards. The Profibus board can be partially or fully removed to allow easy insertion of the 4-lead terminal block onto the Profibus board.

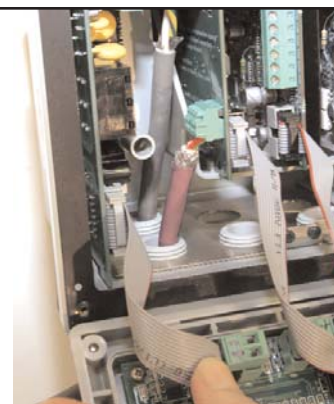

Profibus cable and terminal block installed to Profibus board

- Ensure that the 10-lead ribbon cable is properly connected from the Profibus board to the 10-pin shrouded connector labeled "DIG I/O" on the main printed circuit board. Once power is wired to the unit (as shown in photo), the Profibus-configured Model 1056 is ready for power up and communication on a Profibus network.

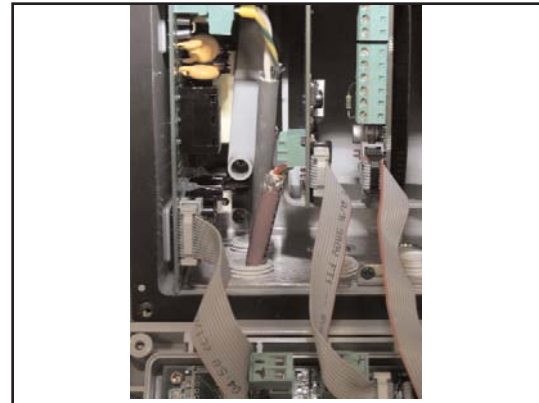

**Complete Profibus board installation
with ribbon cable attached**

3.3 WIRING TO A PROFIBUS NETWORK WITH AN M12 ADAPTOR CABLE ASSEMBLY

Alternatively, Profibus-configured Model 1056 can be wired to a Profibus network using an M12 adaptor cable assembly. The adaptor assembly kit accessory offered by Rosemount Analytical is designed to connect to a standard Profibus network T-cable which is directly connected to the Profibus network.

The M12 cable adaptor assembly is an ordering option. The kit is not provided with the Profibus-configured Model 1056. See Sec. 6.0 Profibus Accessories for ordering information.

The M12 cable adaptor is an interconnect cable between the communications board and the Profibus network. The 5-pin female connector on the fitting end of the M12 cable adaptor allows direct interface to a Profibus network. The M12 cable adaptor kit includes:

- threaded metal adaptor fitting with soldered 4-lead cable and ground wire
- threaded metal nut and o-ring to secure metal fitting and cable to enclosure through an opening
- Instruction sheet



M12 adaptor cable assembly

M12 cable assembly installation

- Install the M12 cable adaptor through enclosure opening on the leftmost side of the enclosure nearest the front of the door hinge. See photo.



**M12 adaptor cable assembly
secured to grounding plate.**

2. Secure the M12 cable assembly with the metal threaded nut from the outside of the enclosure to ensure a proper seal.

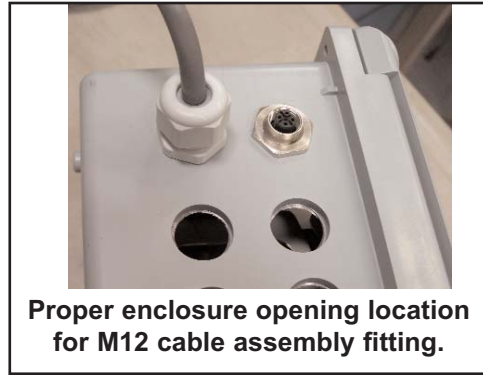

3. Remove the 4-lead terminal block which is installed on the Profibus slide-in board. Wire the four leads of the cable assembly to the 4-lead removable terminal block. The lead positions are labeled on the Profibus board (Black, Green, Red, White) to assist in wiring. Follow the wiring sequence indicated on the Profibus board (see photo). A #0 Phillips head screwdriver is required to open and close the terminal posts on the provided terminal block.

Note: that Profibus wiring is polarity-sensitive. The Green color lead must be wired to lead position A. The Red color lead must be wired to lead position B.

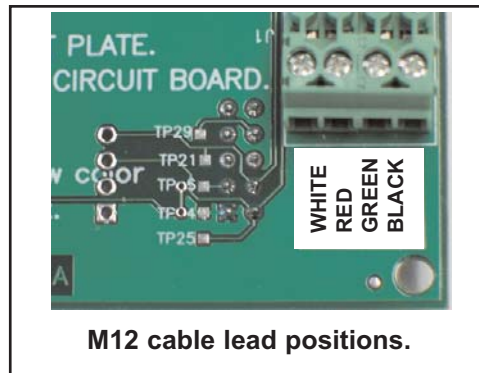
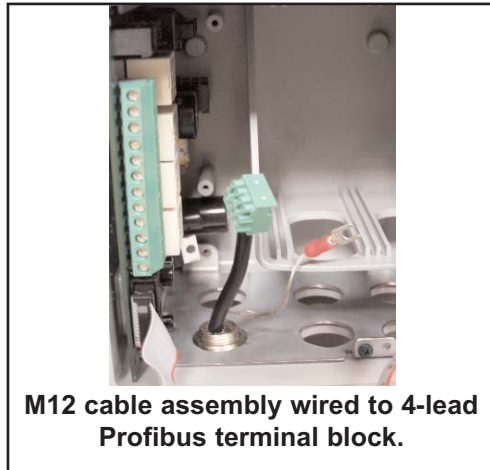

- Slide the wired 4-lead terminal block onto the 4 pins protruding from Profibus board on the left side.

Note: the Profibus cable must be directed downwards. The Profibus board can be partially or fully removed to allow easy insertion of the 4-lead terminal block onto the Profibus board.

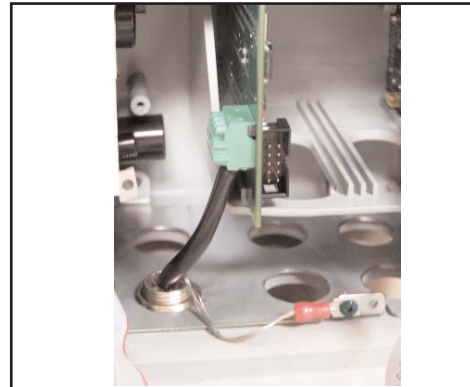

Wired 4-lead terminal block installed on Profibus DP board.

Ensure that the 10-lead ribbon cable is properly connected from the Profibus board to the 10-pin shrouded connector labeled "DIG I/O" on the main printed circuit board (see photo).



Complete M12 cable assembly installation

- Connect the Model 1056 Profibus unit to a Profibus network cable (purple) using standard Profibus connectors and cable fittings. Once power is wired to the unit (as shown in photo), the Profibus-configured Model 1056 is ready for power up and communication on a Profibus network.

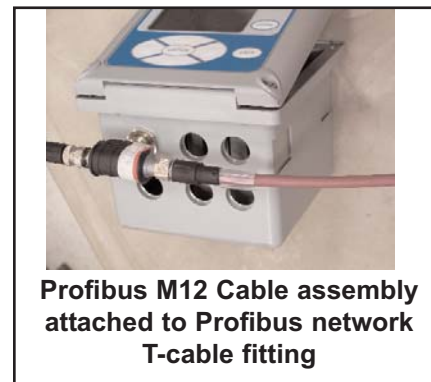

Profibus M12 Cable assembly attached to Profibus network T-cable fitting

SECTION 4.0

PROGRAMMING PROFIBUS

4.1 CHANGING PROFIBUS ADDRESS AT THE DEVICE

Properly wired and configured Profibus Model 1056 units can be accessed by the Profibus master after a GSD file is downloaded to the Master. See Appendix A for details on the GSD file available from Rosemount Analytical.

The only programmable setting that may need to be changed is the default Profibus address or Profibus address that was entered upon initial Quick Start routine.

Note that the Profibus device network address can also be changed from the master unit.

4.1 CHANGING PROFIBUS ADDRESS AT THE DEVICE

Profibus-configured Model 1056 units (Model number 1056-0X-2X-3X-DP) include a pre-installed Profibus communications board that is recognized by the main PCB.

To change the Profibus address,

1. Press MENU. Then select Program. The following screen will appear.

S1: 1.234µS/cm	25.0°C
S2: 12.34pH	25.0°C
Program	
Profibus	
Outputs	
Alarms	
Measurement	

2. Select Profibus. The following screen will appear.

S1: 1.234µS/cm	25.0°C
S2: 12.34pH	25.0°C
Profibus	
Address:	<u>126</u>

3. Using the keypad, enter a numeric Profibus network address from 000-125 for the Model 1056 Profibus unit already commissioned.

SECTION 5.0

DEVICE CONNECTION TO PROFIBUS NETWORK

5.1 COMMUNICATIONS ARCHITECTURE- OVERVIEW

5.2 DATA TRANSMISSION

5.3 DEVICE DATABASE FILE (GSD FILE)

5.1 COMMUNICATIONS ARCHITECTURE- OVERVIEW

The PROFIBUS-DP communications profile specifies the operating characteristics of a serial fieldbus intended for the interconnection of distributed digital devices at the field level. To achieve this, PROFIBUS designates these devices as either masters or slaves:

- Masters, or active stations, control the transmission of data around the bus. A master may transmit messages freely although, sometimes, it may have to obtain network access rights (in the case of multi-master applications using tokenpassing).
- Slaves, or passive stations, are distributed devices (I/O devices, valves, instrumentation transmitters, etc.) that do not have bus access rights without authorization. Their operation is limited to acknowledging messages received or transmitting messages at the request of a master device. In order to route data to its destination address, or to tell the destination address how to handle the data received, a formal set of rules and conventions for the exchange of data signals is required.

The International Standards Organization (ISO) uses an outline model referred to as the Open Systems Interconnection (OSI) reference model. This reference model defines 7 levels used in the transfer of data. These levels are referred to as layers. PROFIBUS-DP operates on the two lowest levels, layer 1 (physical connections) and layer 2 (data links). Layers 3 to 7 are unused in this profile.

5.2 DATA TRANSMISSION

PROFIBUS-DP is designed for efficient communication between programmable logic controllers (PLCs), industrial PCs (IPCs), etc., and distributed peripheral devices such as I/O devices, drives, valves, and measurement sensors, etc. Most data exchanges are carried out in a cyclic fashion. The communication functions required are specified by the basic PROFIBUS-DP communications profile, in accordance with the European harmonized standard, EN 50170.

5.3 DEVICE DATABASE FILE (GSD FILE)

PROFIBUS devices may be defined in terms of their performance and their available functions, e.g. the number of I/O signals and diagnostic messages, and their bus settings, such as transmission speeds or time monitoring. These settings will vary with the equipment type and manufacturer but they are usually defined in the manufacturer's documentation.

To simplify PROFIBUS configuration or even make it transparent to the user, this data is collected together into a single computer file, sometimes referred to as a device data base file or, more often, a GSD file.

GSD files provide a clear and complete description of a device's properties. The **Model 1056** device has its own GSD file.

Model 1056 GSD files may be downloaded free from the GSD library on the web server at:

http://www.emersonprocess.com/raihome/liquid/products/AMS_FIELDDBUS.asp

SECTION 6.0 PROFIBUS ACCESSORIES

6.1 PROFIBUS NETWORK ACCESSORIES 6.2 MODEL 1056 PROFIBUS ACCESSORIES 6.3 SPARE PARTS TABLE

Accessories are available to support connection of Profibus devices to a Profibus network and Profibus master unit.

6.1 PROFIBUS NETWORK ACCESSORIES.

Common Profibus network parts are available to assist with commissioning Profibus devices. The following parts are available for purchase through Rosemount Analytical. Ordering part numbers and images of these parts are included in this section.

- M12 T-connector
- M12 Terminating resistor
- M12 Bus cable, 2-position, 1 m
- M12 Bus cable, 2-position, 0.5 m
- M12 Bus plug connector, male, straight, 5-position, shielded
- M12 Bus plug connector, female, straight, 5- position, shielded

6.2 MODEL 1056 PROFIBUS ACCESSORIES

Rosemount Analytical offers an adaptor kit that allows connection of the Model 1056 Profibus instrument to a Profibus network. This is an alternative to the conventional method of wiring a Profibus network cable directly to the Profibus board installed in the Model 1056 Profibus instrument. The kit contents include:

- a. M12 4-pin adaptor assembly including 4 soldered leads and a ground wire
- b. M12 threaded adaptor nut for installing the M12 adaptor assembly into an enclosure opening of the Model 1056 unit
- c. o-ring for threaded adaptor nut to allow watertight sealing of the M12 adaptor assembly to the enclosure of Model 1056 unit
- d. instruction sheet for kit assembly and installation

Ordering information for the M12 adaptor assembly offered by Rosemount Analytical:

Part Number	Description
24301-00	M12 adaptor assembly kit

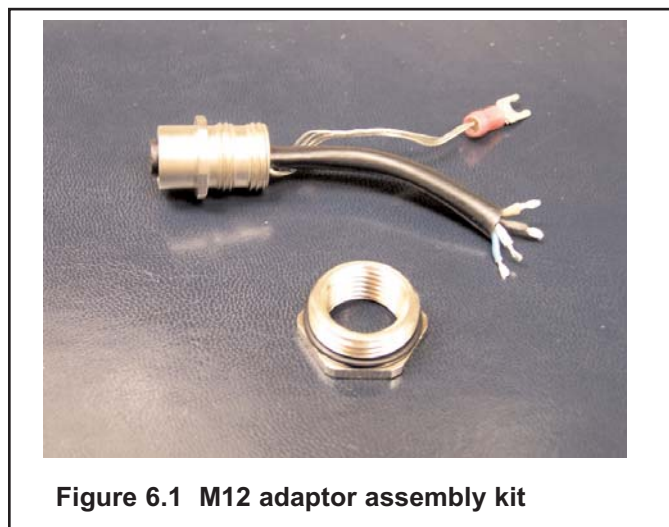

Figure 6.1 M12 adaptor assembly kit

6.3 Spare parts table

Profibus network accessories







Part Number	Description	Image
9120705	PROFIBUS M12 T-connector	
9120706	PROFIBUS M12 Terminating resistor	
9200344	PROFIBUS M12 Bus cable, 2-position, 1 m	
9200345	PROFIBUS M12 Bus cable, 2-position, 0.5 m	
9120707	PROFIBUS M12 Bus plug connector, male, straight, 5-position, shielded	
9120708	PROFIBUS M12, Bus plug connector, female, straight, 5- position, shielded	

Figure 6.2 Profibus network accessories.

SECTION 7.0

PROFIBUS DIAGNOSTICS, FAULTS, WARNINGS

7.1 PROFIBUS DIAGNOSTICS

7.2 PROFIBUS FAULT AND WARNINGS

7.3 TROUBLESHOOTING PROFIBUS FAULT AND WARNINGS

7.1 PROFIBUS DIAGNOSTICS

Profibus-configured Model 1056 units offer a number of useful diagnostics to assist in start up and communications troubleshooting.

To access Profibus diagnostics,

1. Press DIAG. The following screen will appear if a Profibus-related fault or warning exists.

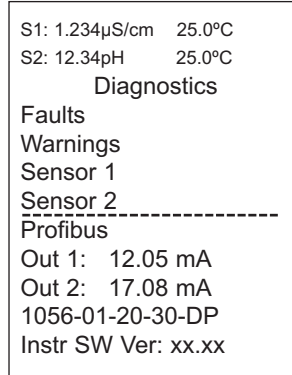

2. Scroll down and select Profibus. Press ENTER. Based on the condition of the Profibus installation and network connection, a number of diagnostics may appear.

The following is a list of all possible Profibus diagnostics and their requisite conditions.

Profibus Diagnostics	Condition
Profi-board mismatch	Profibus board is incompatible with main board.
Function limited	Profibus board has new features that main board does not support
Self-test passed	All power-on self-tests passed
Self-test failed	Any power-on self-test failed
Master detected	At least 1 Profibus message received
Master not detected	No Profibus message has been received
Cable open or short	Cable is detected as open or shorted
Wires A & B reversed	Cable is detected as reversed
Cable good	Cable is detected as properly connected
Board SW Ver: 1.01	Information only: Indicates software version of Profibus board
Address: 126	Information only: Indicates Profibus device address
Baud rate: 115200	Information only: Indicates Profibus communications transmission

7.2 PROFIBUS FAULT AND WARNINGS

Profibus-related Fault and Warning conditions will be automatically detected and indicated on the Model 1056 display. The main display of the Model 1056 includes a Fault and Warning banner on the lower portion of the display that will intermittently flash if any Fault or Warning condition exists.

Profibus-related Fault conditions are detected errors that require immediate operator intervention to correct Profibus communication problems related to hardware, software, or network integrity.

Profibus-related Warning conditions are less critical errors or potential problems related to Profibus hardware, software, or network integrity. Operator intervention is advised to inspect and diagnose these conditions.

To locally access details about Profibus Fault and Warning conditions,

1. Press DIAG. The following screen will appear if a Profibus fault or warning exists.

S1: 1.234µS/cm	25.0°C
S2: 12.34pH	25.0°C
Diagnostics	
Faults	
Warnings	
Sensor 1	
Sensor 2	

Profibus	
Out 1: 12.05 mA	
Out 2: 17.08 mA	
1056-01-20-30-DP	
Instr SW Ver: xx.xx	

2. Select Fault and/or Warning. Press ENTER. Based on the condition of the Profibus installation and network connection, there are three Faults and three Warnings that can be generated. The following table provides all possible Profibus Faults and Warnings and lists their conditions and probable causes.

Displayed Text:	Condition	Probable Cause(s)
Fault: Profi-board Mismatch	If Profibus card major revision is not in the main board's Profibus major revisions list.	Main board software is too old.
Fault: Profi Self-Test Fail	At least one of the internal power-on self-tests failed.	Bad hardware component.
Fault: Profi Internal Comm	Main board detects a Profibus card installed, but Profibus card is not sending messages to the main board.	Bad hardware component.

Displayed Text:	Condition	Probable Cause(s)
Warning: Profibus short/open	Detected when static potential on Profibus B lead <= static potential on A lead.	No Profibus cable connected or A and B wires are shorted.
Warning: Profibus wires A & B reversed	Detected when data activity is present on Profibus, but data polarity is observed as inverted.	Profibus A and B wires are reversed.
Warning: Profibus function limited	If Profibus card minor revision is greater than the main board's minor revision.	Main board software is too old.

7.3 TROUBLESHOOTING PROFIBUS FAULT AND WARNINGS

Model 1056 provides on-screen User Help information and advice to directly assist the user in troubleshooting Fault and/or Warning conditions.

Once the individual Fault or Warning condition is displayed, the user can access User Help for each Fault and Warning condition.

To access User Help for displayed individual Fault conditions,

1. If more than one Fault condition exists, scroll to the Fault condition of interest.
2. Press ENTER. The following table provides User Help screens that appear for individual Fault conditions:

User Help screens
Fault: Profi-board Mismatch 1. Replace Profibus board. 2. Replace main board.
Fault: Profi Self-Test Fail 1. Cycle power. 2. Replace Profibus board.
Fault: Profi Internal Comm 1. Cycle power. 2. Replace Profibus card.

To access User Help for displayed individual Warning conditions,

1. If more than one Warning condition exists, scroll to the Warning condition of interest.
2. Press ENTER. The following table provides User Help screens that appear for individual Warning conditions:

User Help screens
Warning: Profibus short/open Check wiring.
Warning: Profibus wires A & B reversed Check wiring.
Warning: Profibus function limited Replace main board.

NOTES:



The right people, the right answers, right now.

Immediate, Reliable Analytical Support

Now there's a way to quickly get the right answers for your liquid analytical instrumentation questions: the Analytical Customer Support Center.

Our staff of trained professionals is ready to provide the information you need. If you are placing an order, verifying delivery, requesting application information, or just want to contact a Rosemount Analytical representative, a call to the Customer Support Center will provide you with the right people, the right answers, right now.

A Worldwide Network of Sales and Service

Emerson Process Management's field sales offices are your source for more information on the full line of Rosemount Analytical products. Field sales personnel will work closely with you to supply technical data and application information.

For more information, please contact your nearest Emerson Process Management sales office.

THE AMERICAS - HEADQUARTERS

Rosemount Analytical Inc.
Liquid Division
2400 Barranca Parkway
Irvine, CA 92606
Phone: 949-757-8500
Toll Free: 800-854-8257
Fax: 949-474-7250

ASIA-PACIFIC

Fisher-Rosemount
Singapore Private Ltd.
1 Pandan Crescent
Singapore 0512
Republic of Singapore
Phone: 65-777-8211
Fax: 65-777-0947

EUROPE, MIDDLE EAST, AND AFRICA

Fisher-Rosemount Ltd.
Heath Place
Bognor Regis
West Sussex PO22 9SH
England
Phone: 44-1243-863121
Fax: 44-1243-845354

ADDITIONAL SALES OFFICES IN:

Argentina	India	Romania
Australia	Indonesia	Russia
Austria	Ireland	Saudi Arabia
Azerbaijan	Israel	Singapore
Bahrain	Italy	Slovak Republic
Belgium	Jamaica	South Africa
Bolivia	Japan	Spain
Brazil	Jordan	Sweden
Brunei	Kazakhstan	Switzerland
Bulgaria	Korea	Syria
Canada	Kuwait	Taiwan
Chile	Malaysia	Thailand
China	Mexico	Tobago
Colombia	Netherlands	Trinidad
Costa Rica	New Zealand	Tunisia
Croatia	Nigeria	Turkey
Czech Republic	Norway	Ukraine
Denmark	Oman	United Arab Emirates
Egypt	Pakistan	United Kingdom
Ecuador	Paraguay	Uruguay
Finland	Peru	Uzbekistan
France	Philippines	Venezuela
Germany	Poland	Yemen
Greece	Portugal	
Hong Kong	Puerto Rico	
Hungary	Qatar	

VISIT OUR WEBSITE AT
www.RAIhome.com



*The right people,
the right answers,
right now.*

**ROSEMOUNT ANALYTICAL
CUSTOMER SUPPORT CENTER
1-800-854-8257**



ON-LINE ORDERING NOW AVAILABLE ON OUR WEB SITE
<http://www.raihome.com>

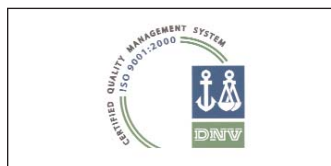

Credit Cards for U.S. Purchases Only.



Emerson Process Management

Rosemount Analytical Inc.

2400 Barranca Parkway
Irvine, CA 92606 USA
Tel: (949) 757-8500
Fax: (949) 474-7250

<http://www.raihome.com>

